

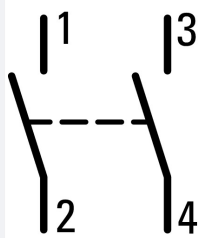



Key-operated actuator, RMQ Compact, momentary, 2 N/O, Screw connection, 2 positions, MS2, Bezel: titanium

Part no. C22-WS-MS2-K20
 Catalog No. 136718
 Alternate Catalog No. C22-WS-MS2-K20

Delivery program

Product range			RMQ Compact
Basic function			Key-operated buttons
Single unit/Complete unit			Complete unit momentary
Function:			
			 40°
Connection type			Screw connection Not suitable for master key systems 2 positions
Lock mechanism			MS2
Key withdrawable in position			0
Degree of Protection			IP66
Front ring			Bezel: titanium
Connection to SmartWire-DT			no
Contacts			
N/O = Normally open			2 N/O
Contact sequence			
Contact travel <input checked="" type="checkbox"/> = Contact closed <input type="checkbox"/> = Contact open			
Contact diagram			
Information about equipment supplied			With 1 key

Technical data

General		
Standards		IEC/EN 60947-5-1 VDE 0660
Lifespan, mechanical	Operations x 10 ⁶	> 0.1
Operating frequency	Operations/h	≤ 100
Operating torque	Nm	≤ 0.5
Climatic proofing		Damp heat, constant, to IEC 60068-2-78 Damp heat, cyclic, to IEC 60068-2-30
Degree of Protection		IP66
Mounting position		As required
Terminal capacities	mm ²	
Solid	mm ²	2 x 0.5 - 1.5
Flexible with ferrule	mm ²	2 x 0.5 - 1.5

Tightening torque for terminal screw		Nm	0.8
Contacts			
Rated impulse withstand voltage	U_{imp}	V AC	4000
Rated insulation voltage	U_i	V	250
Rated conditional short-circuit current	I_q	kA	1
Overvoltage category/pollution degree			III/3
Control circuit reliability			
at 24 V DC/5 mA	H_F	Fault probability	values follow
at 5 V DC/1 mA	H_F	Fault probability	values follow
Max. short-circuit protective device			
Fuse	gG/gL	A	10

Technical data ETIM 7.0

Low-voltage industrial components (EG000017) / Selector switch, complete (EC001029)			
Electric engineering, automation, process control engineering / Low-voltage switch technology / Command and alarm device / Selector switch, complete unit (ecl@ss10.0.1-27-37-12-43 [ACN984011])			
Number of switch positions			2
Type of control element			Key
Suitable for illumination			No
With light source			No
Colour button			Black
Hole diameter		mm	22.5
Width opening		mm	0
Height opening		mm	0
Switching function latching			No
Spring-return			Yes
Degree of protection (IP)			IP66
Degree of protection (NEMA)			
Supply voltage		V	0 - 0
Number of contacts as normally open contact			2
Number of contacts as normally closed contact			0
Number of contacts as change-over contact			0
Type of electric connection			Screw connection
With front ring			Yes
Material front ring			Plastic
Colour front ring			Other

Approvals

Product Standards			IEC/EN 60947-5-1; UL 508; CAN/CSA-C22.2 No. 14-05 und 94-M91; CE marking
UL File No.			E29184
UL Category Control No.			NKCR
CSA File No.			165628
CSA Class No.			321103
North America Certification			UL listed, CSA certified
Degree of Protection			1,3R,4X,12,13

Dimensions

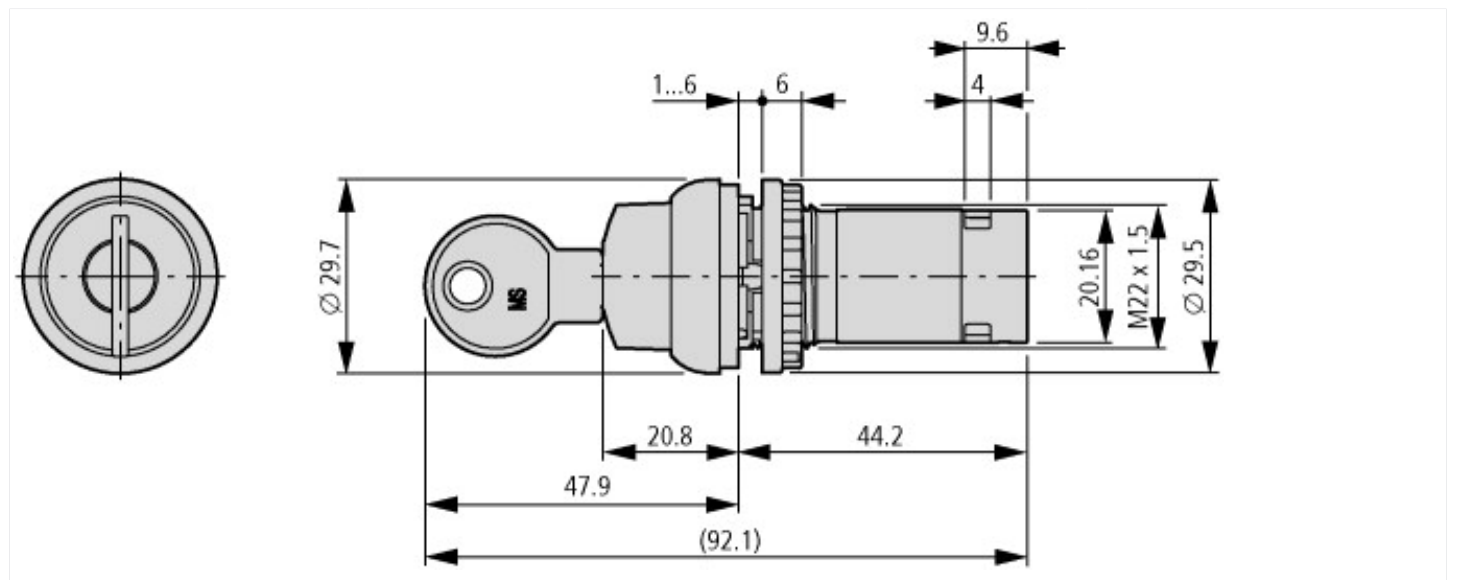

Additional product information (links)

IL04716025Z RMQ-Titan: compact programm

IL04716025Z RMQ-Titan: compact programm https://es-assets.eaton.com/DOCUMENTATION/AWA_INSTRUCTIONS/IL04716025Z2021_05.pdf