

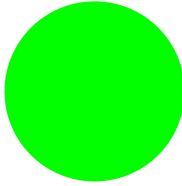

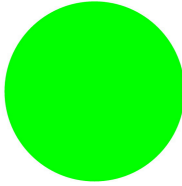
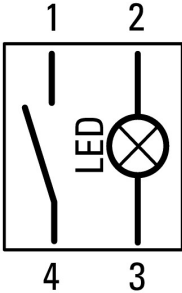

Illuminated pushbutton actuator, Flat, momentary, 1 N/O, Cable (black) with M8 plug, 4 pole, 0.2 m, LED green, green, Blank, 24 V AC/DC, Bezel: titanium

Part no. C22-DL-G-K10-24-P30
 Catalog No. 185562

Delivery program

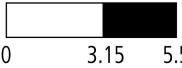
| | | |
|---|---|--|
| Product range | | RMQ compact solution |
| Basic function | | Illuminated pushbutton actuators |
| Single unit/Complete unit | | Complete unit |
| Design | | Flat momentary |
| Connection type | | Cable (black) with M8 plug, 4 pole |
| Cable Length | m | 0.2 |
| Colour | | |
| LED | |  |
| LED | | green |
| Button plate | | |
| button plate | | green |
| Button plate | |  |
| | | Blank |
| Rated operational voltage LED | | 24 V AC/DC |
| Name | | None |
| Degree of Protection | | IP66, IP67, IP69 (front) IP65 (on rear) |
| Front ring | | Bezel: titanium |
| Connection to SmartWire-DT | | no |
| Contacts | | |
| N/O = Normally open | | 1 N/O |
| Contact sequence | |  |
| Contact travel  = Contact closed  = Contact open | | |
| Contact diagram | |  |

Technical data

General

| | | | |
|---|--------------|---------------|--|
| Standards | | | IEC/EN 60947-5-1 VDE 0660 |
| Certifications | | | CE, UL, CSA |
| Lifespan, mechanical | Operations | $\times 10^6$ | > 1 |
| Operating frequency | Operations/h | | ≤ 3600 |
| Actuating force | | n | ≤ 5 |
| Plug tightening torque | | N/m | 0.6 |
| Tightening torque Threaded ring | | Nm | 2 |
| Climatic proofing | | | Damp heat, constant, to IEC 60068-2-78 Damp heat, cyclic, to IEC 60068-2-30 |
| Degree of Protection | | | IP66, IP67, IP69 (front) IP65 (on rear) |
| Ambient temperature | | | |
| Open | | °C | -30 - +70 |
| Storage | | °C | -30 - +80 |
| Mounting position | | | As required |
| Mechanical shock resistance, shock duration 11 ms | | g | > 30 |

Contacts

| | | | |
|---|-----------|------|--|
| Rated impulse withstand voltage | U_{imp} | V AC | 800 |
| Rated insulation voltage | U_i | V | 30 |
| Overvoltage category/pollution degree | | | III/3 |
| Control circuit reliability | | | |
| At 17 V DC/7 mA | H_F | | N/O: 1 failure per 17×10^6 switching operations, statistically determined |
| Max. short-circuit protective device | | | |
| Fuse | gG/gL | A | 4 |
| Rated conditional short-circuit current | I_q | kA | 1 |

Switching capacity

| | | | |
|---------------------------|-------|---|---|
| Rated operational current | I_e | A | |
| AC-15 | | | |
| 24 V | I_e | A | 4 |
| DC-13 | | | |
| 24 V | I_e | A | 3 |

Cable characteristics

| | | | |
|-------------------------|---------------|----|-----|
| Design | | | M8 |
| Cable Length | | m | 0.2 |
| Material characteristic | | | PUR |
| Diameter | \varnothing | mm | 4.7 |

Design verification as per IEC/EN 61439

| | | | |
|--|--|----|-----|
| Technical data for design verification | | | |
| Operating ambient temperature min. | | °C | -30 |
| Operating ambient temperature max. | | °C | 70 |

Technical data ETIM 7.0

| | | | |
|---|--|----|-------|
| Low-voltage industrial components (EG000017) / Push button, complete (EC001028) | | | |
| Electric engineering, automation, process control engineering / Low-voltage switch technology / Command and alarm device / Push-button actuator, complete unit (ecl@ss10.0.1-27-37-12-28 [AKF046014]) | | | |
| Number of command positions | | | 1 |
| Type of button | | | Flat |
| Colour button | | | Green |
| Construction type lens | | | Round |
| Hole diameter | | mm | 22.5 |
| Width opening | | mm | 0 |
| Height opening | | mm | 0 |
| Suitable for illumination | | | Yes |

| | | |
|---|---|---------|
| Switching function latching | | No |
| Spring-return | | Yes |
| Supply voltage lamp | V | 24 |
| Number of contacts as normally open contact | | 1 |
| Number of contacts as normally closed contact | | 0 |
| Number of contacts as change-over contact | | 0 |
| Type of electric connection | | Other |
| With front ring | | Yes |
| Material front ring | | Plastic |
| Colour front ring | | Grey |
| Degree of protection (IP) | | Other |
| Degree of protection (NEMA) | | Other |

Approvals

| | | |
|-----------------------------|--|---|
| Product Standards | | IEC/EN 60947-5-1; UL 508; CAN/CSA-C22.2 No. 14-18 and No. 94.2-15; CE marking |
| UL File No. | | E29184 |
| UL Category Control No. | | NKCR |
| CSA File No. | | 165628 |
| CSA Class No. | | 321103 |
| North America Certification | | UL listed, CSA certified |
| Degree of Protection | | 2, 12 |

Dimensions

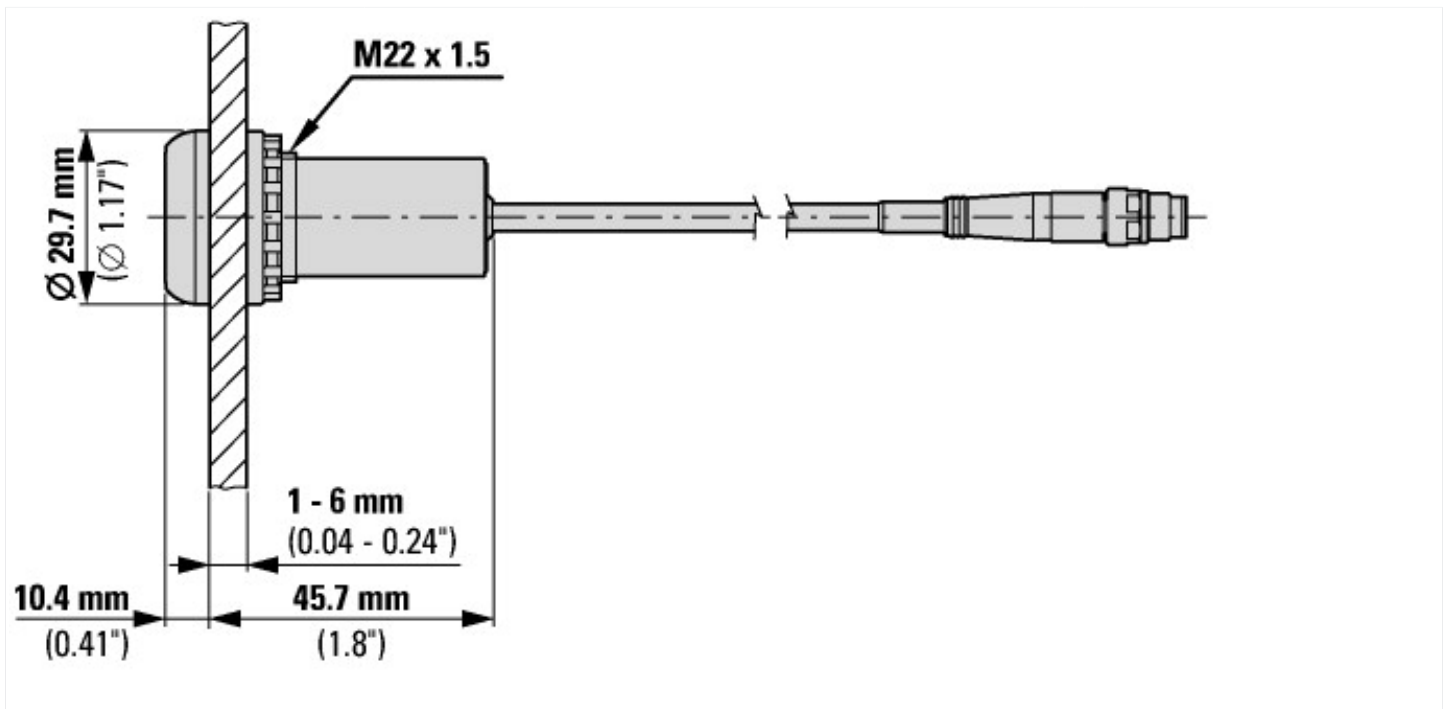

Assets (links)

Declaration of CE Conformity

00003256

Instruction Leaflets

IL047016ZU2018_06

Additional product information (links)

IL047016ZU RMQ compact solution

IL047016ZU RMQ compact solution ftp://ftp.moeller.net/DOCUMENTATION/AWA_INSTRUCTIONS/IL047016ZU2018_06.pdf