





**Illuminated pushbutton actuator, Extended, momentary, 1 N/O, Screw connection, LED green, green, inscribed, 24 V AC/DC, Bezel: titanium**

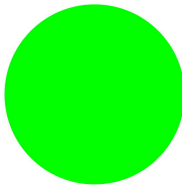
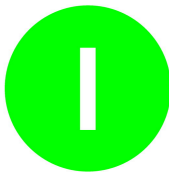
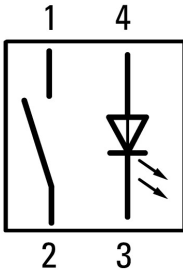

**Part no.** C22-DLH-G-X1-K10-24  
**Catalog No.** 132558  
**Alternate Catalog No.** C22-DLH-G-X1-K10-24

**Delivery program**

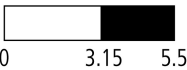
Product range		RMQ Compact
Basic function		Illuminated pushbutton actuators
Single unit/Complete unit		Complete unit
Design		Extended momentary
Connection type		Screw connection
<b>Colour</b>		
LED		
LED		green
<b>Button plate</b>		
button plate		green
Button plate		
		inscribed
Rated operational voltage LED		24 V AC/DC
Name		I
Degree of Protection		IP66, IP67, IP69
Front ring		Bezel: titanium
Connection to SmartWire-DT		no
<b>Contacts</b>		
N/O = Normally open		1 N/O
Contact sequence		
<b>Contact travel</b>  = Contact closed  = Contact open		
Contact diagram		

**Technical data**

<b>General</b>		
Standards		IEC/EN 60947-5-1

			VDE 0660
Lifespan, mechanical	Operations	$\times 10^6$	> 5
Operating frequency	Operations/h		$\leq 3600$
Actuating force	n		$\leq 5$
Climatic proofing			Damp heat, constant, to IEC 60068-2-78 Damp heat, cyclic, to IEC 60068-2-30
Degree of Protection			IP66, IP67, IP69
Ambient temperature			
Open	°C		-25 - +70
Storage	°C		- -30 - + 80
Mounting position			As required
Terminal capacities		mm <sup>2</sup>	
Solid		mm <sup>2</sup>	2 x 0.5 - 1.5_x
Flexible with ferrule		mm <sup>2</sup>	2 x 0.5 - 1.5_x
Tightening torque for terminal screw		Nm	0.8

## Contacts

Rated impulse withstand voltage	$U_{imp}$	V AC	4000
Rated insulation voltage	$U_i$	V	250
Rated conditional short-circuit current	$I_q$	kA	1
Overvoltage category/pollution degree			III/3
Control circuit reliability			
at 24 V DC/5 mA	$H_F$	Fault probability	values follow
at 5 V DC/1 mA	$H_F$	Fault probability	values follow
Max. short-circuit protective device			
Fuse	gG/gL	A	10

## Design verification as per IEC/EN 61439

Technical data for design verification			
Operating ambient temperature min.		°C	-25
Operating ambient temperature max.		°C	70

## Technical data ETIM 7.0

Low-voltage industrial components (EG000017) / Push button, complete (EC001028)			
Electric engineering, automation, process control engineering / Low-voltage switch technology / Command and alarm device / Push-button actuator, complete unit (ecl@ss10.0.1-27-37-12-28 [AKF046014])			
Number of command positions			1
Type of button			High
Colour button			Green
Construction type lens			Round
Hole diameter		mm	22.5
Width opening		mm	0
Height opening		mm	0
Suitable for illumination			Yes
Switching function latching			No
Spring-return			Yes
Supply voltage lamp		V	24
Number of contacts as normally open contact			1
Number of contacts as normally closed contact			0
Number of contacts as change-over contact			0
Type of electric connection			Screw connection
With front ring			Yes
Material front ring			Plastic
Colour front ring			Other
Degree of protection (IP)			Other

## Approvals

Product Standards	IEC/EN 60947-5-1; UL 508; CAN/CSA-C22.2 No. 14-05 und 94-M91; CE marking
UL File No.	E29184
UL Category Control No.	NKCR
CSA File No.	165628
CSA Class No.	321103
North America Certification	UL listed, CSA certified
Degree of Protection	1,3R,4X,12,13

## Dimensions

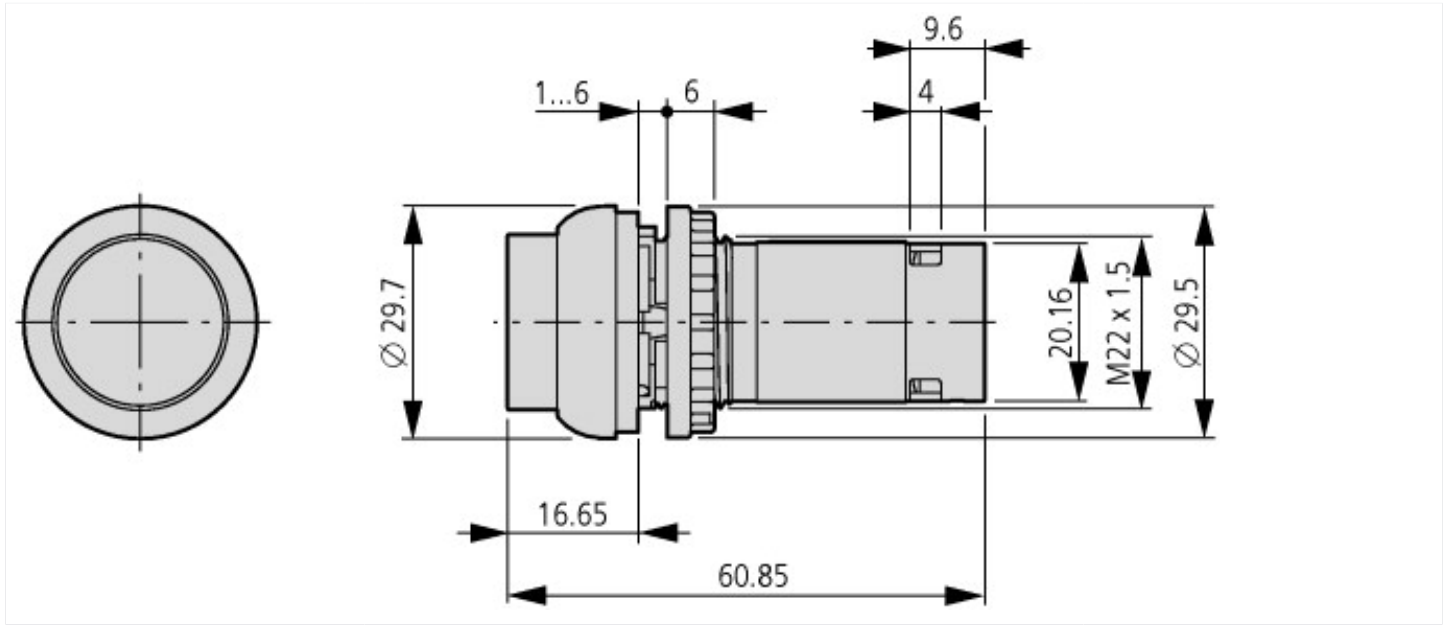

## Additional product information (links)

IL04716025Z RMQ-Titan: compact programm

IL04716025Z RMQ-Titan: compact programm

[https://es-assets.eaton.com/DOCUMENTATION/AWA\\_INSTRUCTIONS/IL04716025Z2021\\_05.pdf](https://es-assets.eaton.com/DOCUMENTATION/AWA_INSTRUCTIONS/IL04716025Z2021_05.pdf)