







Illuminated pushbutton actuator, Extended, momentary, 1 N/O, Screw connection, LED Blue, Blue, Blank, 120 V AC, Bezel: titanium

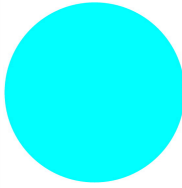
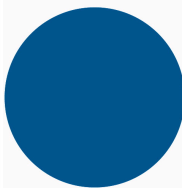
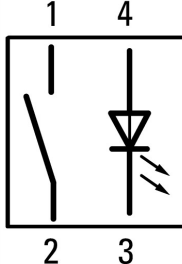

Part no. C22-DLH-B-K10-120
Catalog No. 136642
Alternate Catalog No. C22-DLH-B-K10-120

Delivery program

Product range		RMQ Compact
Basic function		Illuminated pushbutton actuators
Single unit/Complete unit		Complete unit
Design		Extended momentary
Connection type		Screw connection
Colour		
LED		
LED		Blue
Button plate		
button plate		Blue
Button plate		
		Blank
Rated operational voltage LED		120 V AC
Name		None
Degree of Protection		IP66, IP67, IP69
Front ring		Bezel: titanium
Connection to SmartWire-DT		no
Contacts		
N/O = Normally open		1 N/O
Contact sequence		
Contact travel  = Contact closed  = Contact open		
Contact diagram		

Technical data

General		
Standards		IEC/EN 60947-5-1

			VDE 0660
Lifespan, mechanical	Operations	$\times 10^6$	> 5
Operating frequency	Operations/h		≤ 3600
Actuating force	n		≤ 5
Climatic proofing			Damp heat, constant, to IEC 60068-2-78 Damp heat, cyclic, to IEC 60068-2-30
Degree of Protection			IP66, IP67, IP69
Ambient temperature			
Open	°C		-25 - +70
Storage	°C		- -30 - + 80
Mounting position			As required
Terminal capacities	mm^2		
Solid	mm^2		2 x 0.5 - 1.5_x
Flexible with ferrule	mm^2		2 x 0.5 - 1.5_x
Tightening torque for terminal screw	Nm		0.8

Contacts

Rated impulse withstand voltage	U_{imp}	V AC	4000
Rated insulation voltage	U_i	V	250
Rated conditional short-circuit current	I_q	kA	1
Overvoltage category/pollution degree			III/3
Control circuit reliability			
at 24 V DC/5 mA	H_F	Fault probability	values follow
at 5 V DC/1 mA	H_F	Fault probability	values follow
Max. short-circuit protective device			
Fuse	gG/gL	A	10

Design verification as per IEC/EN 61439

Technical data for design verification			
Operating ambient temperature min.		°C	-25
Operating ambient temperature max.		°C	70

Technical data ETIM 7.0

Low-voltage industrial components (EG000017) / Push button, complete (EC001028)			
Electric engineering, automation, process control engineering / Low-voltage switch technology / Command and alarm device / Push-button actuator, complete unit (ecl@ss10.0.1-27-37-12-28 [AKF046014])			
Number of command positions			1
Type of button			High
Colour button			Blue
Construction type lens			Round
Hole diameter		mm	22.5
Width opening		mm	0
Height opening		mm	0
Suitable for illumination			Yes
Switching function latching			No
Spring-return			Yes
Supply voltage lamp		V	120
Number of contacts as normally open contact			1
Number of contacts as normally closed contact			0
Number of contacts as change-over contact			0
Type of electric connection			Screw connection
With front ring			Yes
Material front ring			Plastic
Colour front ring			Other
Degree of protection (IP)			Other

Approvals

Product Standards	IEC/EN 60947-5-1; UL 508; CAN/CSA-C22.2 No. 14-05 und 94-M91; CE marking
UL File No.	E29184
UL Category Control No.	NKCR
CSA File No.	165628
CSA Class No.	321103
North America Certification	UL listed, CSA certified
Degree of Protection	1,3R,4X,12,13

Dimensions

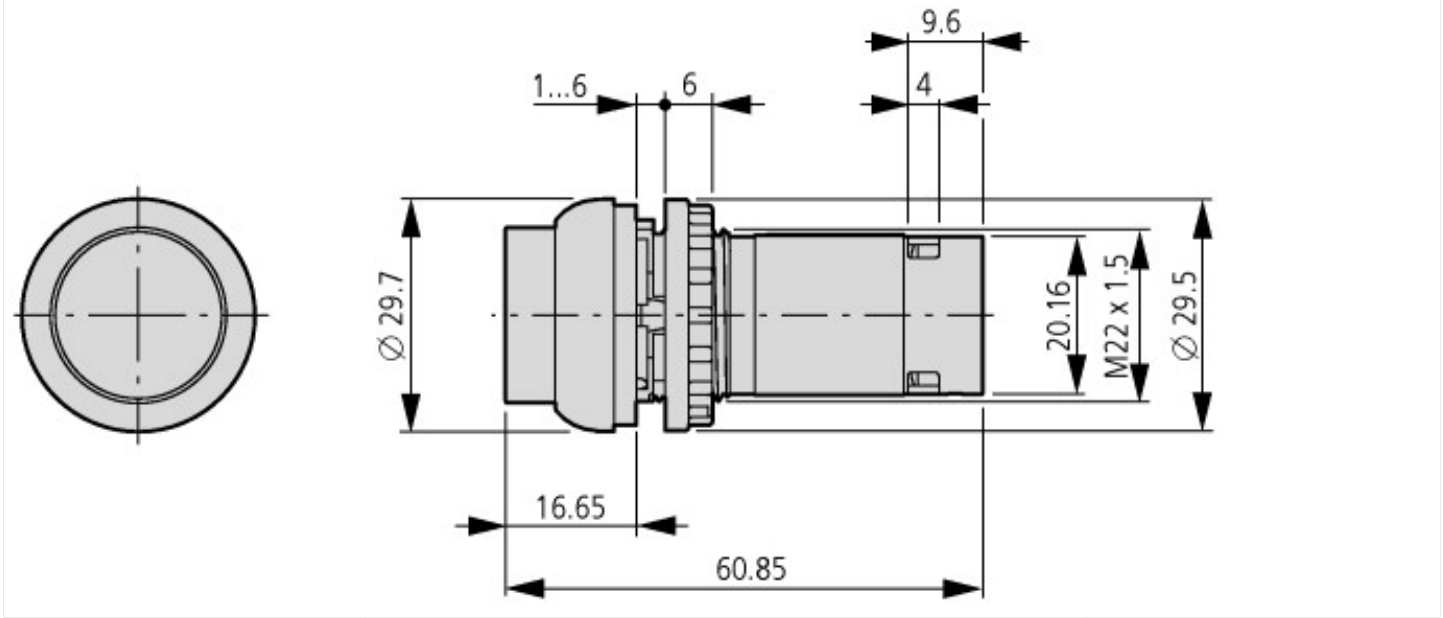

Additional product information (links)

IL04716025Z RMQ-Titan: compact programm

IL04716025Z RMQ-Titan: compact programm

https://es-assets.eaton.com/DOCUMENTATION/AWA_INSTRUCTIONS/IL04716025Z2021_05.pdf