





Illuminated pushbutton actuator, Extended, momentary, 1 N/O, Screw connection, LED Blue, Blue, Blank, 24 V AC/DC, Bezel: titanium

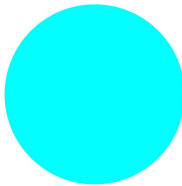
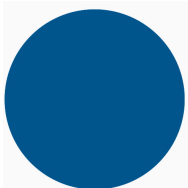
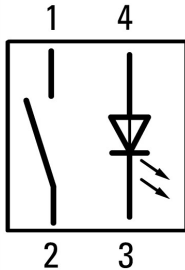

Part no. C22-DLH-B-K10-24
Catalog No. 136644
Alternate Catalog No. C22-DLH-B-K10-24

Delivery program

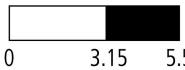
| | | |
|---|--|--|
| Product range | | RMQ Compact |
| Basic function | | Illuminated pushbutton actuators |
| Single unit/Complete unit | | Complete unit |
| Design | | Extended momentary |
| Connection type | | Screw connection |
| Colour | | |
| LED | |  |
| LED | | Blue |
| Button plate | | |
| button plate | | Blue |
| Button plate | |  |
| | | Blank |
| Rated operational voltage LED | | 24 V AC/DC |
| Name | | None |
| Degree of Protection | | IP66, IP67, IP69 |
| Front ring | | Bezel: titanium |
| Connection to SmartWire-DT | | no |
| Contacts | | |
| N/O = Normally open | | 1 N/O |
| Contact sequence | |  |
| Contact travel  = Contact closed  = Contact open | | |
| Contact diagram | |  |

Technical data

| | | |
|----------------|--|------------------|
| General | | |
| Standards | | IEC/EN 60947-5-1 |

| | | | |
|--------------------------------------|--------------|-----------------|--|
| | | | VDE 0660 |
| Lifespan, mechanical | Operations | $\times 10^6$ | > 5 |
| Operating frequency | Operations/h | | ≤ 3600 |
| Actuating force | n | | ≤ 5 |
| Climatic proofing | | | Damp heat, constant, to IEC 60068-2-78 Damp heat, cyclic, to IEC 60068-2-30 |
| Degree of Protection | | | IP66, IP67, IP69 |
| Ambient temperature | | | |
| Open | °C | | -25 - +70 |
| Storage | °C | | - -30 - + 80 |
| Mounting position | | | As required |
| Terminal capacities | | mm ² | |
| Solid | | mm ² | 2 x 0.5 - 1.5_x |
| Flexible with ferrule | | mm ² | 2 x 0.5 - 1.5_x |
| Tightening torque for terminal screw | | Nm | 0.8 |

Contacts

| | | | |
|---|-----------|-------------------|---------------|
| Rated impulse withstand voltage | U_{imp} | V AC | 4000 |
| Rated insulation voltage | U_i | V | 250 |
| Rated conditional short-circuit current | I_q | kA | 1 |
| Overvoltage category/pollution degree | | | III/3 |
| Control circuit reliability | | | |
| at 24 V DC/5 mA | H_F | Fault probability | values follow |
| at 5 V DC/1 mA | H_F | Fault probability | values follow |
| Max. short-circuit protective device | | | |
| Fuse | gG/gL | A | 10 |

Design verification as per IEC/EN 61439

| | | | |
|--|--|----|-----|
| Technical data for design verification | | | |
| Operating ambient temperature min. | | °C | -25 |
| Operating ambient temperature max. | | °C | 70 |

Technical data ETIM 7.0

| | | | |
|---|--|----|------------------|
| Low-voltage industrial components (EG000017) / Push button, complete (EC001028) | | | |
| Electric engineering, automation, process control engineering / Low-voltage switch technology / Command and alarm device / Push-button actuator, complete unit (ecl@ss10.0.1-27-37-12-28 [AKF046014]) | | | |
| Number of command positions | | | 1 |
| Type of button | | | High |
| Colour button | | | Blue |
| Construction type lens | | | Round |
| Hole diameter | | mm | 22.5 |
| Width opening | | mm | 0 |
| Height opening | | mm | 0 |
| Suitable for illumination | | | Yes |
| Switching function latching | | | No |
| Spring-return | | | Yes |
| Supply voltage lamp | | V | 24 |
| Number of contacts as normally open contact | | | 1 |
| Number of contacts as normally closed contact | | | 0 |
| Number of contacts as change-over contact | | | 0 |
| Type of electric connection | | | Screw connection |
| With front ring | | | Yes |
| Material front ring | | | Plastic |
| Colour front ring | | | Other |
| Degree of protection (IP) | | | Other |

Approvals

| | |
|-----------------------------|--|
| Product Standards | IEC/EN 60947-5-1; UL 508; CAN/CSA-C22.2 No. 14-05 und 94-M91; CE marking |
| UL File No. | E29184 |
| UL Category Control No. | NKCR |
| CSA File No. | 165628 |
| CSA Class No. | 321103 |
| North America Certification | UL listed, CSA certified |
| Degree of Protection | 1,3R,4X,12,13 |

Dimensions

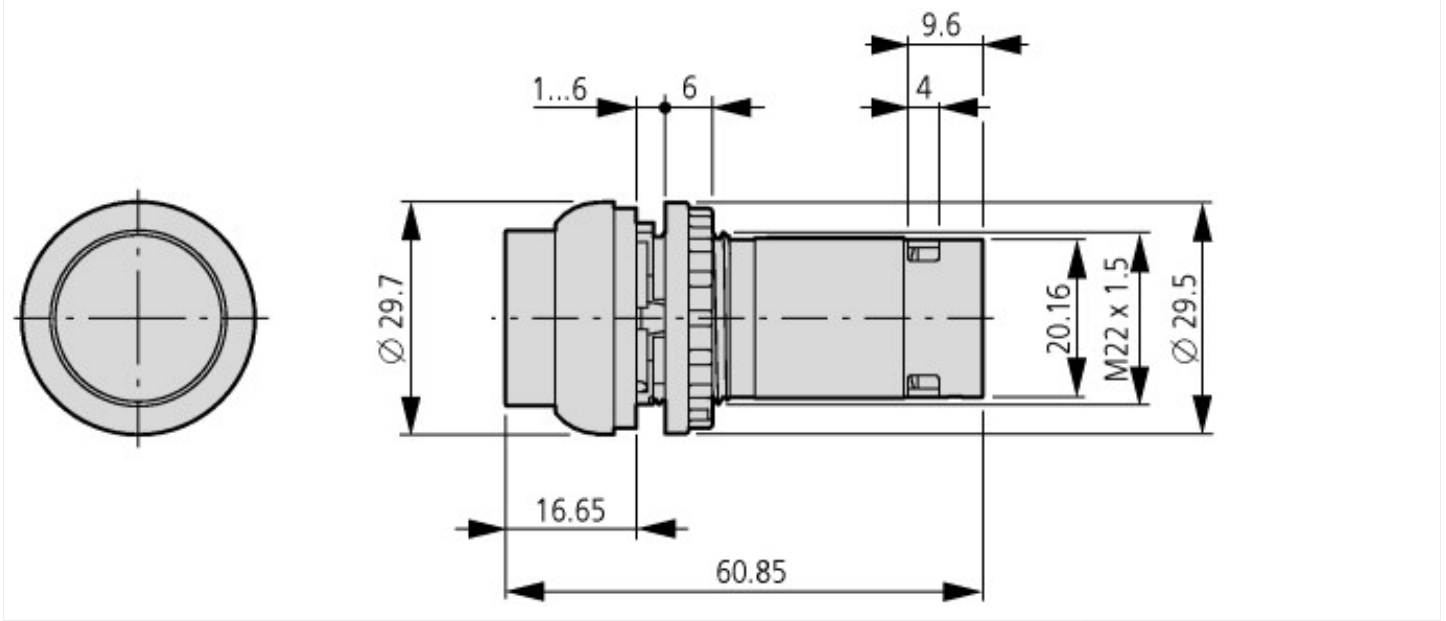

Additional product information (links)

IL04716025Z RMQ-Titan: compact programm

IL04716025Z RMQ-Titan: compact programm

https://es-assets.eaton.com/DOCUMENTATION/AWA_INSTRUCTIONS/IL04716025Z2021_05.pdf