





Circuit-breaker, 4p, 60A, box terminals

**Part no.** NZMB2-4-AF60-BT-NA  
**Catalog No.** 153380  
**Alternate Catalog No.** NZMB2-4-AF60-BT-NA

Similar to illustration

## Delivery program

Product range				Circuit-breaker
Protective function				System and cable protection
Standard/Approval				UL/CSA, IEC
Release system				Thermomagnetic release
Installation type				Fixed
Description				Switches conform to UL/CSA as well as the IEC regulations. IEC switching performance values are contained on the rating plate. Fixed overload releases Ir
Frame size				NZM2
Number of poles				4 pole
Standard equipment				Box terminal
<b>Switching capacity</b>				
SCCR 480Y/277 V 60 Hz	I <sub>cu</sub>	kA		25
SCCR 480 V 60 Hz	I <sub>cu</sub>	kA		25
<b>Rated current = rated uninterrupted current</b>				
Rated current = rated uninterrupted current	I <sub>n</sub> = I <sub>u</sub>	A		60
Neutral conductor	% of phase conductor	%		100
<b>Setting range</b>				
Overload trip				
	I <sub>r</sub>	A		60 - 60
Main pole 	I <sub>r</sub>	A		60 - 60
Neutral conductor				
Neutral conductor	% of phase conductor	%		100
Short-circuit releases				
Non-delayed 	I <sub>i</sub> = I <sub>n</sub> X ...			6 - 10

## Technical data

### General

Standards				IEC/EN 60947
Protection against direct contact				Finger and back of hand proof to VDE 0106 Part 100
Climatic proofing				Damp heat, constant, to IEC 60068-2-78 Damp heat, cyclic, to IEC 60068-2-30
Ambient temperature				
Ambient temperature, storage		°C		- 40 - + 70
Operation		°C		-25 - +70
Mechanical shock resistance (10 ms half-sinusoidal shock) according to IEC 60068-2-27		g		20 (half-sinusoidal shock 20 ms)

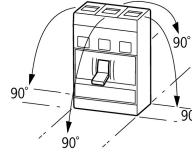
Safe isolation to EN 61140			
Between auxiliary contacts and main contacts		V AC	500
between the auxiliary contacts		V AC	300
Mounting position			
Mounting position			<p>Vertical and 90° in all directions</p>  <p>With residual-current release XFI:  - NZM1, N1, NZM2, N2: vertical and 90° in all directions  with plug-in adapter elements  - NZM1, N1, NZM2, N2: vertical, 90° right/left  with withdrawable unit:  - NZM3, N3: vertical, 90 ° left  - NZM4, N4: vertical  with remote operator:  - NZM2, N(S)2, NZM3, N(S)3, NZM4, N(S)4: vertical and 90° in all directions</p>
Direction of incoming supply			as required
Degree of protection			
Device			In the operating controls area: IP20 (basic degree of protection)
Enclosures			With insulating surround: IP40, with door coupling rotary handle: IP66
Terminations			Tunnel terminal: IP10 Phase isolator and strip terminal: IP00
Other technical data (sheet catalogue)			Weight Temperature dependency, Derating Effective power loss

### Circuit-breakers

Rated surge voltage invariability	$U_{imp}$		
Main contacts		V	8000
Auxiliary contacts		V	6000
Rated operational voltage	$U_e$	V AC	440
Overvoltage category/pollution degree			III/3
Rated insulation voltage	$U_i$	V	690
Use in unearthed supply systems		V	≤ 440

### Switching capacity

Rated short-circuit making capacity	$I_{cm}$		
240 V	$I_{cm}$	kA	63
400/415 V	$I_{cm}$	kA	53
440 V 50/60 Hz	$I_{cm}$	kA	53
Rated short-circuit breaking capacity $I_{cn}$	$I_{cn}$		
$I_{cu}$ to IEC/EN 60947 test cycle O-t-CO	$I_{cu}$	kA	
240 V 50/60 Hz	$I_{cu}$	kA	30
400/415 V 50/60 Hz	$I_{cu}$	kA	25
440 V 50/60 Hz	$I_{cu}$	kA	25
$I_{cs}$ to IEC/EN 60947 test cycle O-t-CO-t-CO	$I_{cs}$	kA	
240 V 50/60 Hz	$I_{cs}$	kA	30
400/415 V 50/60 Hz	$I_{cs}$	kA	25
440 V 50/60 Hz	$I_{cs}$	kA	18.5
Maximum low-voltage h.b.c. fuse		A gG/gL	355
			Maximum back-up fuse, if the expected short-circuit currents at the installation location exceed the switching capacity of the circuit-breaker.
<b>Technical data that diverge from products for the IEC market</b>			
Switching capacity of NA switches (UL489, CSA 22.2 No. 5.1)			
Short-circuit current rating SCCR			
SCCR 240 V 60 Hz	$I_{cu}$	kA	35
SCCR 480V/277 V 60 Hz	$I_{cu}$	kA	25
SCCR 480 V 60 Hz	$I_{cu}$	kA	25
Utilization category to IEC/EN 60947-2			A
Lifespan, mechanical(of which max. 50 % trip by shunt/undervoltage release)	Operations		20000
Lifespan, electrical			
AC-1			

400 V 50/60 Hz	Operations	7500
Max. operating frequency	Ops/h	120
Total break time at short-circuit	ms	< 10

### Terminal capacity

Standard equipment		Box terminal
Al conductors, Cu cable		
Tunnel terminal		
Solid	mm <sup>2</sup>	1 x 16

## Design verification as per IEC/EN 61439

Technical data for design verification			
Rated operational current for specified heat dissipation	I <sub>n</sub>	A	60
Equipment heat dissipation, current-dependent	P <sub>vid</sub>	W	18.36
Operating ambient temperature min.		°C	-25
Operating ambient temperature max.		°C	70
IEC/EN 61439 design verification			
10.2 Strength of materials and parts			
10.2.2 Corrosion resistance			Meets the product standard's requirements.
10.2.3.1 Verification of thermal stability of enclosures			Meets the product standard's requirements.
10.2.3.2 Verification of resistance of insulating materials to normal heat			Meets the product standard's requirements.
10.2.3.3 Verification of resistance of insulating materials to abnormal heat and fire due to internal electric effects			Meets the product standard's requirements.
10.2.4 Resistance to ultra-violet (UV) radiation			Meets the product standard's requirements.
10.2.5 Lifting			Does not apply, since the entire switchgear needs to be evaluated.
10.2.6 Mechanical impact			Does not apply, since the entire switchgear needs to be evaluated.
10.2.7 Inscriptions			Meets the product standard's requirements.
10.3 Degree of protection of ASSEMBLIES			Does not apply, since the entire switchgear needs to be evaluated.
10.4 Clearances and creepage distances			Meets the product standard's requirements.
10.5 Protection against electric shock			Does not apply, since the entire switchgear needs to be evaluated.
10.6 Incorporation of switching devices and components			Does not apply, since the entire switchgear needs to be evaluated.
10.7 Internal electrical circuits and connections			Is the panel builder's responsibility.
10.8 Connections for external conductors			Is the panel builder's responsibility.
10.9 Insulation properties			
10.9.2 Power-frequency electric strength			Is the panel builder's responsibility.
10.9.3 Impulse withstand voltage			Is the panel builder's responsibility.
10.9.4 Testing of enclosures made of insulating material			Is the panel builder's responsibility.
10.10 Temperature rise			The panel builder is responsible for the temperature rise calculation. Eaton will provide heat dissipation data for the devices.
10.11 Short-circuit rating			Is the panel builder's responsibility. The specifications for the switchgear must be observed.
10.12 Electromagnetic compatibility			Is the panel builder's responsibility. The specifications for the switchgear must be observed.
10.13 Mechanical function			The device meets the requirements, provided the information in the instruction leaflet (IL) is observed.

## Technical data ETIM 7.0

Low-voltage industrial components (EG000017) / Power circuit-breaker for trafo/generator/installation protection (EC000228)			
Electric engineering, automation, process control engineering / Low-voltage switch technology / Circuit breaker (LV < 1 kV) / Circuit breaker for power transformer, generator and system protection (ecl@ss10.0.1-27-37-04-09 [AJZ716013])			
Rated permanent current I <sub>u</sub>		A	60
Rated voltage		V	440 - 440
Rated short-circuit breaking capacity I <sub>cu</sub> at 400 V, 50 Hz		kA	25
Overload release current setting		A	60 - 60
Adjustment range short-term delayed short-circuit release		A	0 - 0
Adjustment range undelayed short-circuit release		A	6 - 10
Integrated earth fault protection			No
Type of electrical connection of main circuit			Frame clamp

Device construction			Built-in device fixed built-in technique
Suitable for DIN rail (top hat rail) mounting			No
DIN rail (top hat rail) mounting optional			Yes
Number of auxiliary contacts as normally closed contact			0
Number of auxiliary contacts as normally open contact			0
Number of auxiliary contacts as change-over contact			0
With switched-off indicator			No
With under voltage release			No
Number of poles			4
Position of connection for main current circuit			Front side
Type of control element			Rocker lever
Complete device with protection unit			Yes
Motor drive integrated			No
Motor drive optional			Yes
Degree of protection (IP)			IP20

## Approvals

Product Standards			UL 489; CSA-C22.2 No. 5-09; IEC 60947-2; CE marking
UL File No.			E31593
UL Category Control No.			DIVQ
CSA File No.			-
CSA Class No.			-
North America Certification			UL listed
Specially designed for North America			Yes
Suitable for			Feeder circuits, branch circuits
Current Limiting Circuit-Breaker			Yes
Max. Voltage Rating			480 V
Degree of Protection			IEC: IP20; UL/CSA Type: -

# Characteristics

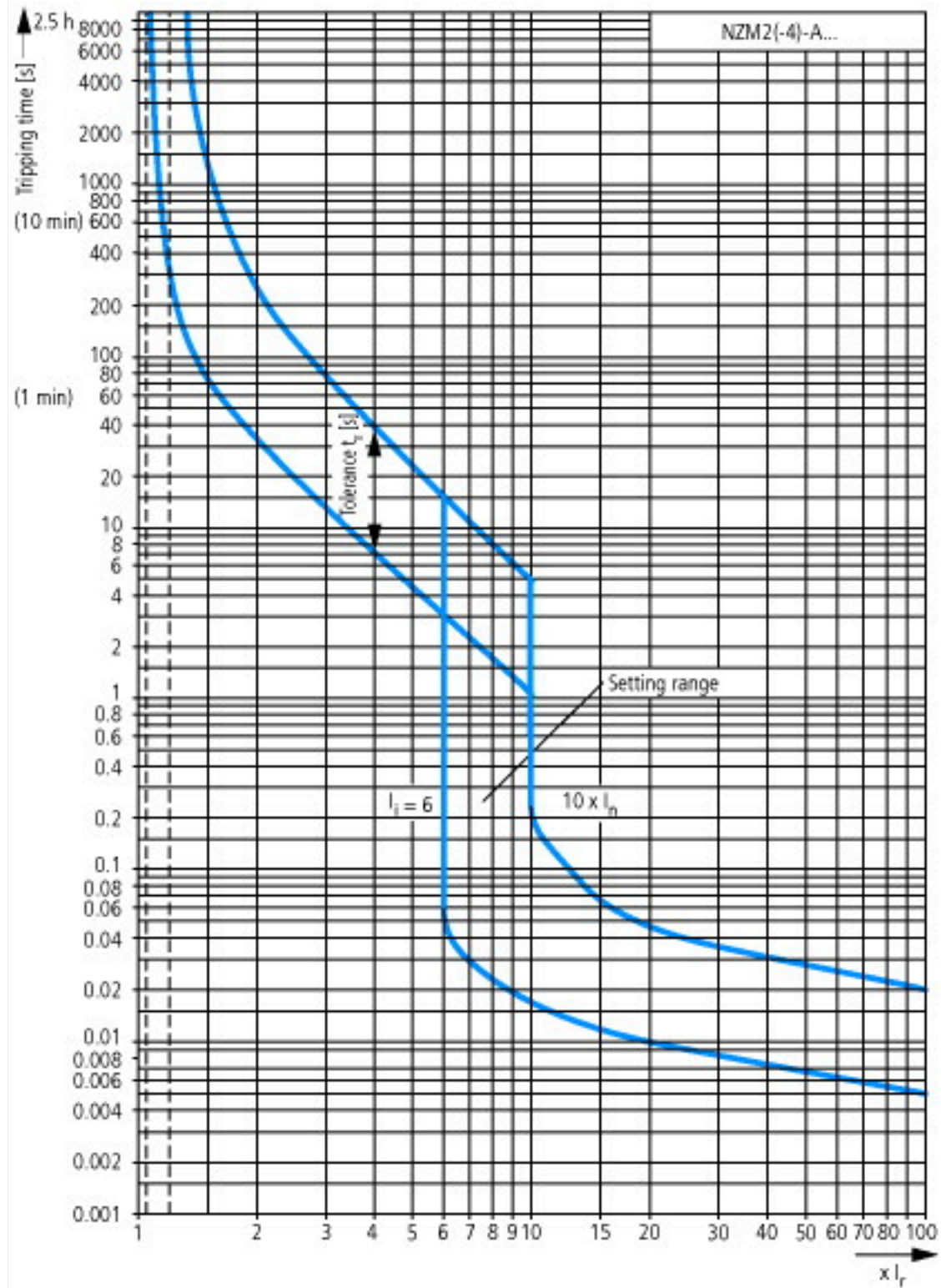

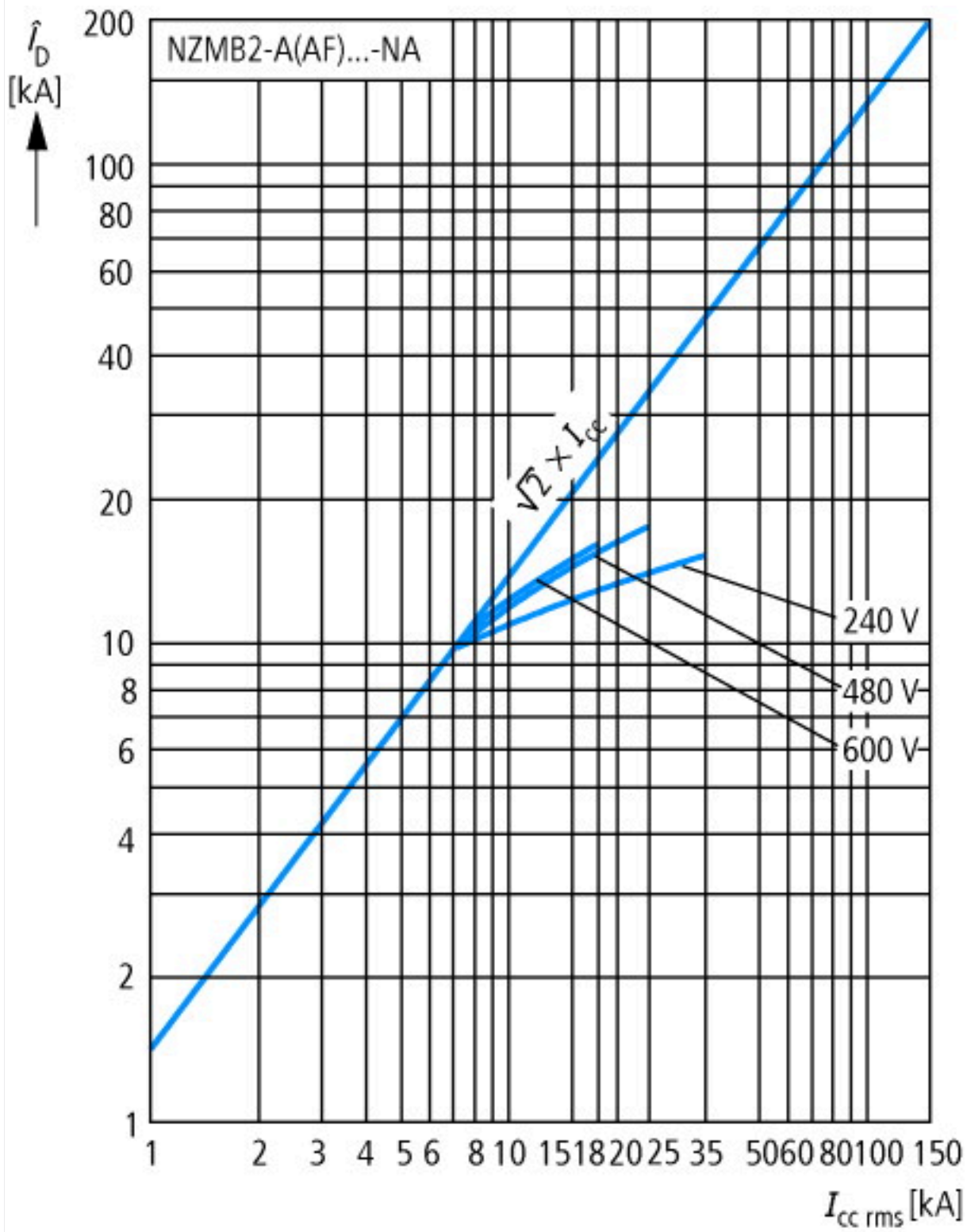

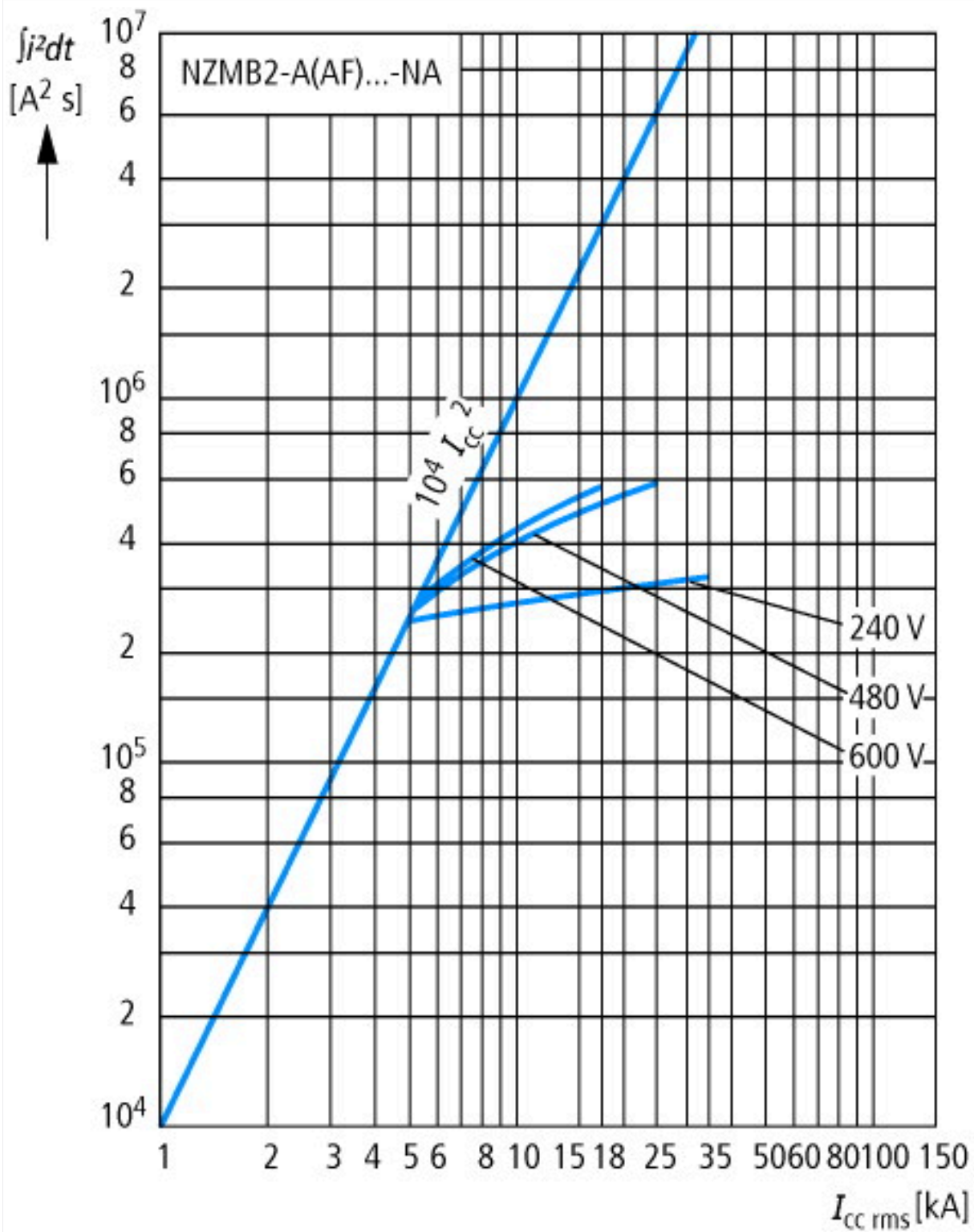

## Dimensions

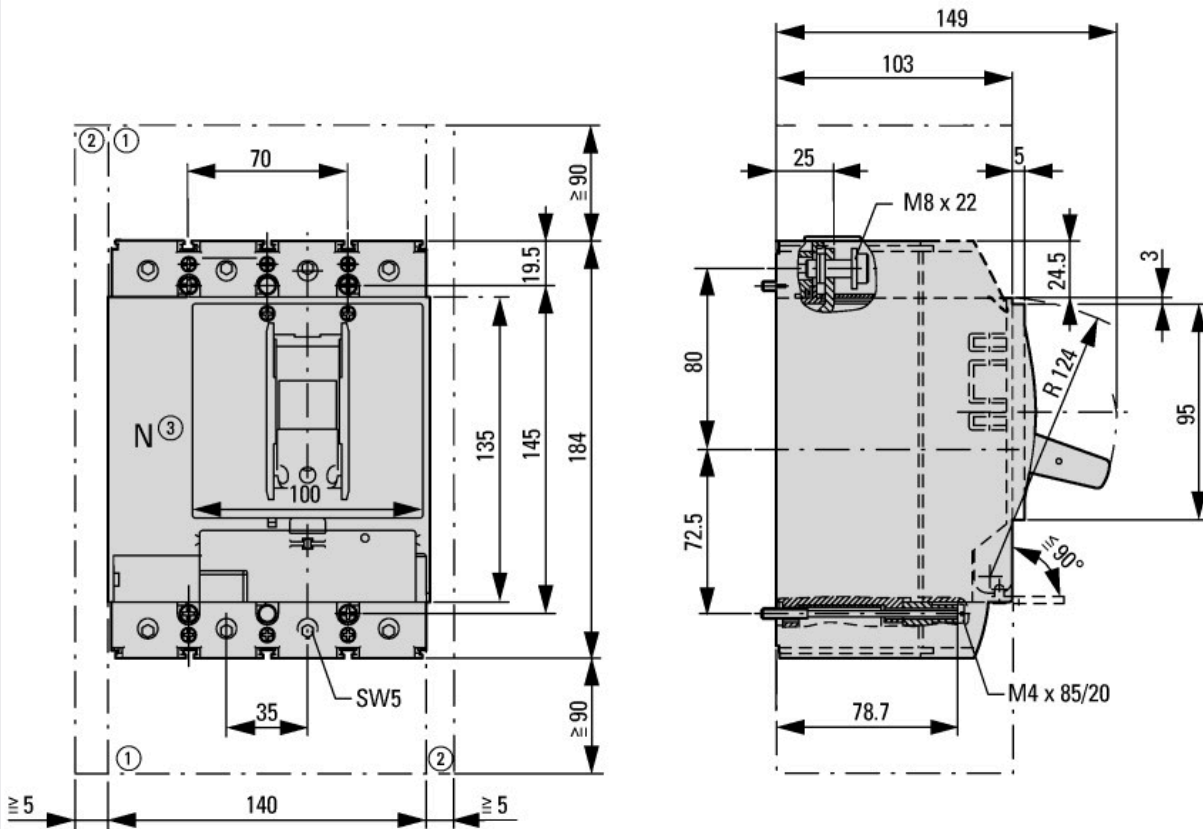

- ① Blow out area, minimum clearance to adjacent parts
- ② Minimum clearance to adjacent parts



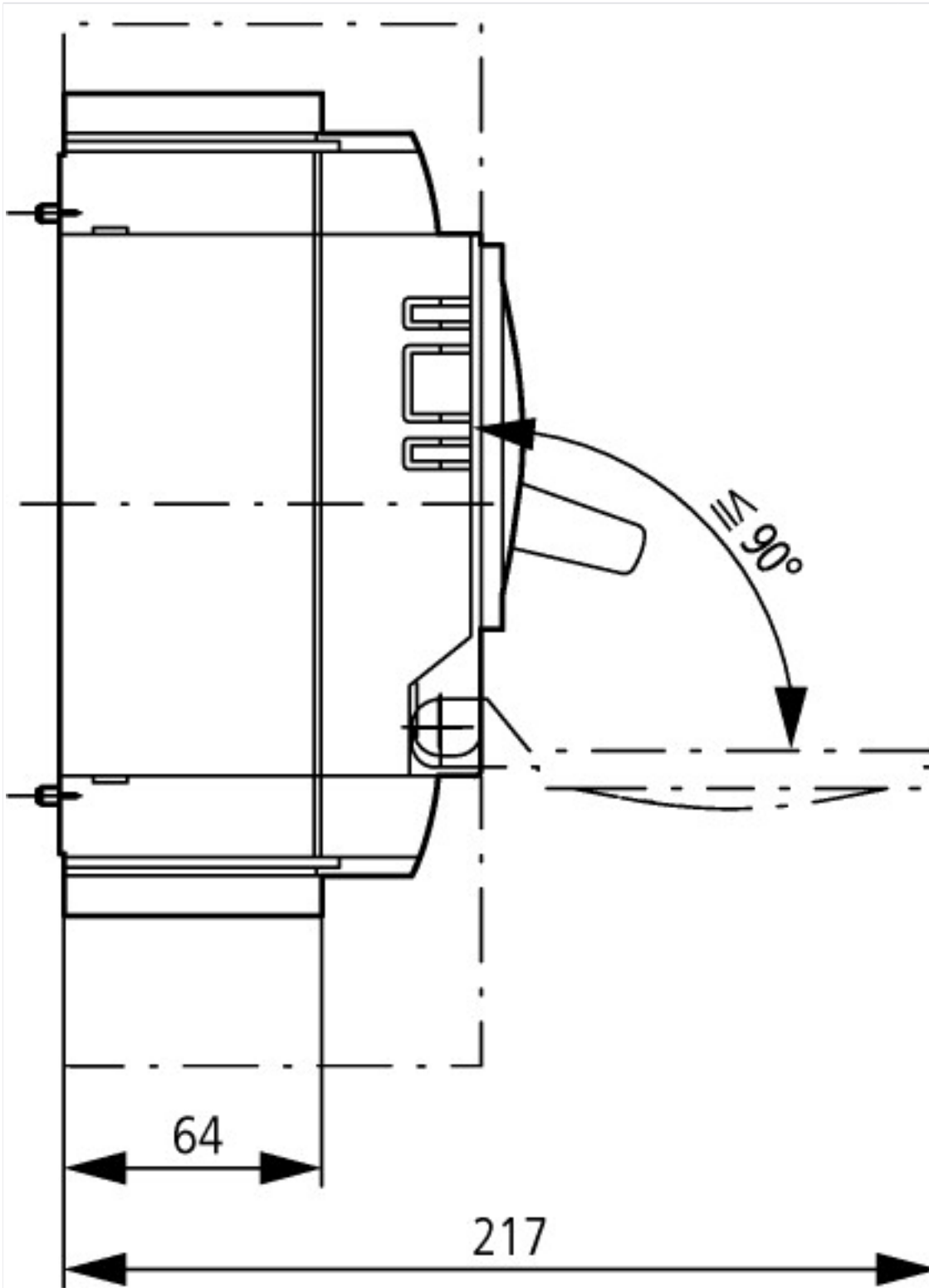

### Additional product information (links)

Weight	<a href="http://ecat.moeller.net/flip-cat/?edition=HPLEN&amp;startpage=17.171">http://ecat.moeller.net/flip-cat/?edition=HPLEN&amp;startpage=17.171</a>
Temperature dependency, Derating	<a href="http://ecat.moeller.net/flip-cat/?edition=HPLEN&amp;startpage=17.172">http://ecat.moeller.net/flip-cat/?edition=HPLEN&amp;startpage=17.172</a>
Effective power loss	<a href="http://ecat.moeller.net/flip-cat/?edition=HPLEN&amp;startpage=17.174">http://ecat.moeller.net/flip-cat/?edition=HPLEN&amp;startpage=17.174</a>
additional technical information for NZM power switch	<a href="https://es-assets.eaton.com/DOCUMENTATION/PDF/nzm_technic_de_en.pdf">https://es-assets.eaton.com/DOCUMENTATION/PDF/nzm_technic_de_en.pdf</a>