



Key-operated actuator, Flat Front, maintained, 2 positions, MS4, Key withdrawable: 0, I, Bezel: stainless steel



Part no. M30I-FWRS-MS4
Catalog No. 188157
Alternate Catalog No. M30I-FWRS-MS4

Delivery program

Product range			Flat Front (drilling dimensions 30.5 mm)
Basic function			Key-operated buttons
Mounting hole diameter	∅	mm	30.5
Single unit/Complete unit			Single unit
Design			Key operation lock mechanism maintained
Function:			
			60°
			Not suitable for master key systems
			2 positions
Lock mechanism			MS4
Key withdrawable in position			
			0
			I
Degree of Protection			IP66
Front ring			Front ring stainless steel
Connection to SmartWire-DT			yes with SWD-RMQ connections
Instructions			Stay-put/spring-return function, can be changed with coding parts M22-XC-Y Key withdraw convertible with coding adapters M22-XC-...
Information about equipment supplied			With 1 key

Technical data

General			
Standards			IEC/EN 60947 VDE 0660
Lifespan, mechanical	Operations	x 10 ⁶	> 0.1
Operating frequency	Operations/h		≤ 100
Operating torque		Nm	≤ 0.5
Climatic proofing			Damp heat, constant, to IEC 60068-2-78 Damp heat, cyclic, to IEC 60068-2-30
Degree of Protection			IP66
Ambient temperature			
Open		°C	-25 - +70
Mounting position			As required
Mechanical shock resistance		g	15 Shock duration 11 ms Sinusoidal according to IEC 60068-2-27
shipping classification			DNV GL



Design verification as per IEC/EN 61439

Technical data for design verification		
Operating ambient temperature min.	°C	-25
Operating ambient temperature max.	°C	70

Technical data ETIM 7.0

Low-voltage industrial components (EG000017) / Front element for selector switch (EC000222)		
Electric engineering, automation, process control engineering / Low-voltage switch technology / Command and alarm device / Front element for selector switches (ecl@ss10.0.1-27-37-12-13 [AKF031014])		
Number of switch positions		2
Type of control element		Key
Suitable for illumination		No
Colour control element		Black
Colour indicator light cap		Other
Construction type lens		Round
Hole diameter	mm	30
Width opening	mm	0
Height opening	mm	0
Switching function latching		Yes
Spring-return		No
With front ring		Yes
Material front ring		Metal
Colour front ring		Other
Degree of protection (IP), front side		IP66
Degree of protection (NEMA)		Other

Approvals

Product Standards		IEC/EN 60947-5; UL 508; CSA-C22.2 No. 14-05; CSA-C22.2 No. 94-91; CE marking
UL File No.		E29184
UL Category Control No.		NKCR
CSA File No.		012528
CSA Class No.		3211-03
North America Certification		UL listed, CSA certified
Degree of Protection		UL/CSA Type 3R, 4X, 12, 13

Dimensions

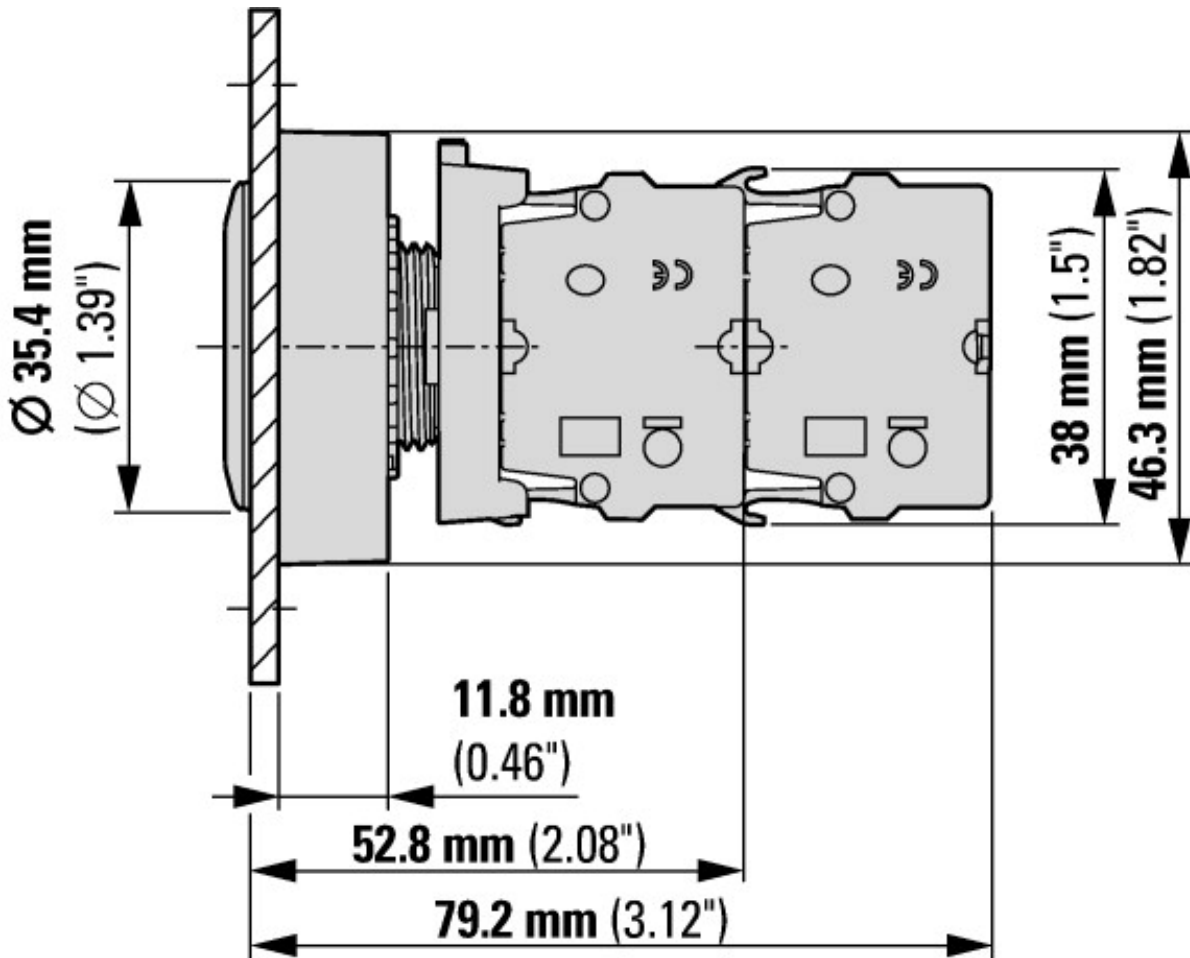
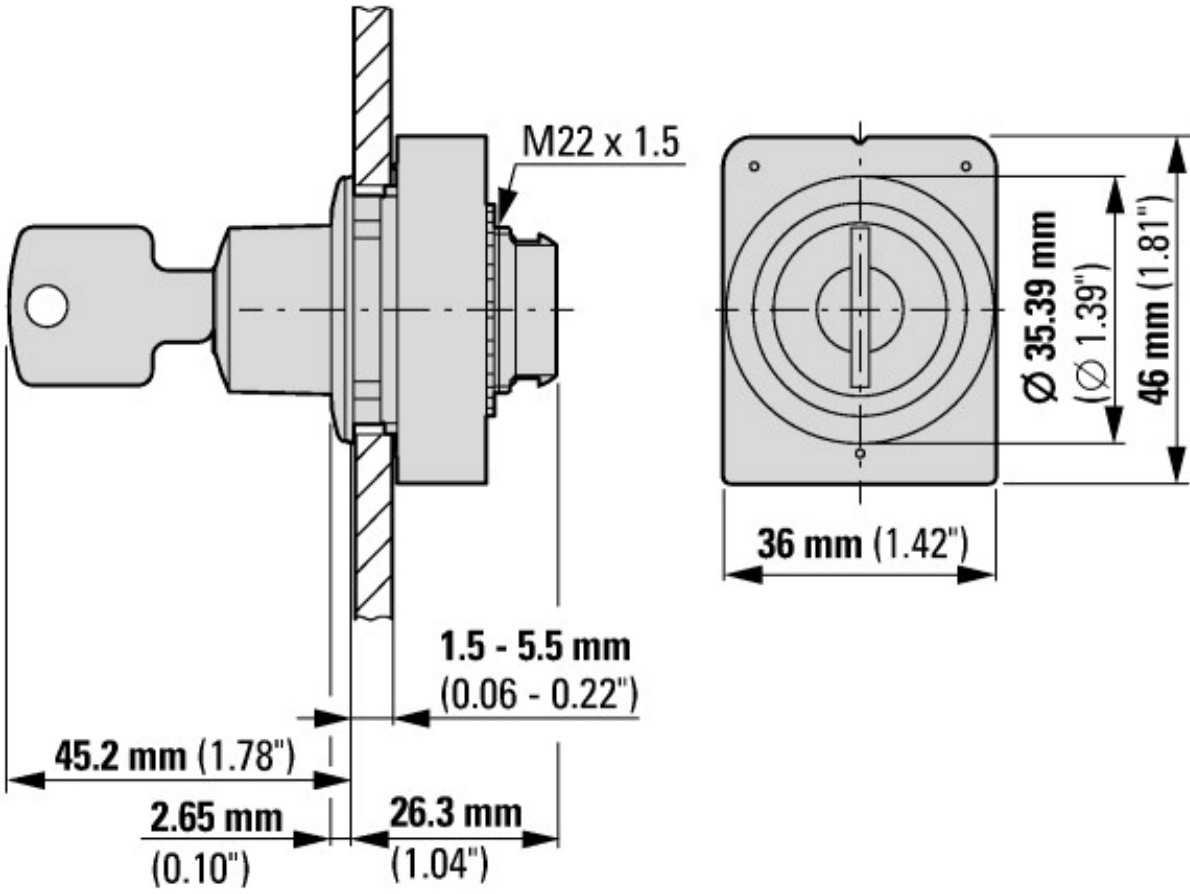

with 2 standard M22-K contact elements...



with flat-rear contact elements M22-FK...

