







**NZM4 PXR25 circuit breaker - integrated energy measurement class 1, 800A, 4p, variable, Screw terminal, withdrawable unit**



**Part no. NZMH4-4-PX800/VAR-AVE**  
**Catalog No. 189667**

### Delivery program

Product range				Circuit-breaker
Protective function				Systems, cable, selectivity and generator protection
Standard/Approval				IEC
Installation type				Withdrawable
Release system				Electronic release
Construction size				NZM4
Description				LSI overload protection and delayed and non-delayed short-circuit protective device Class 1 energy measurement, r.m.s. value measurement, and "thermal memory" USB interface for configuration and test function with Power Xpert Protection Manager software Interface module in equipment supplied. Optionally communication-capable with internal Modbus RTU module or CAM
Number of poles				4 pole
Standard equipment				Screw connection
<b>Switching capacity</b>				
400/415 V 50 Hz	$I_{cu}$	kA		85
<b>Rated current = rated uninterrupted current</b>				
Rated current = rated uninterrupted current	$I_n = I_u$	A		800
Neutral conductor	% of phase conductor	%		0 - 60 - 100
<b>Setting range</b>				
Overload trip				
	$I_r$	A		320 - 800
Short-circuit releases				
				
Non-delayed	$I_i = I_n \times \dots$			2 - 18
				
Delayed	$I_{sd} = I_r \times \dots$			2 - 10
				

### Technical data

#### General

Standards				IEC/EN 60947
Protection against direct contact				Finger and back of hand proof to VDE 0106 Part 100
Climatic proofing				Damp heat, constant, to IEC 60068-2-78 Damp heat, cyclic, to IEC 60068-2-30
Ambient temperature				
Ambient temperature, storage		°C		- 40 - + 70
Operation		°C		-25 - +70
Mechanical shock resistance (10 ms half-sinusoidal shock) according to IEC 60068-2-27		g		15 (half-sinusoidal shock 11 ms)
Safe isolation to EN 61140				
Between auxiliary contacts and main contacts		V AC		500

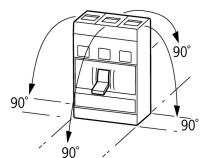
between the auxiliary contacts	V AC	300	
Mounting position		Vertical and 90° in all directions	 <p>With XFI earth-fault release:  - NZM1, N1, NZM2, N2: vertical and 90° in all directions  with plug-in unit  - NZM1, N1, NZM2, N2: vertical, 90° right/left  with withdrawable unit:  - NZM3, N3: vertical, 90° right/left  - NZM4, N4: vertical  with remote operator:  - NZM2, N(S)2, NZM3, N(S)3, NZM4, N(S)4: vertical and 90° in all directions</p>
Direction of incoming supply		as required	
Degree of protection			
Device		In the operating controls area: IP20 (basic degree of protection)	
Enclosures		With insulating surround: IP40 With door coupling rotary handle: IP66	
Terminations		Tunnel terminal: IP10 Phase isolator and strip terminal: IP00	
Other technical data (sheet catalogue)		Weight Temperature dependency, Derating Effective power loss	

### Circuit-breakers

Rated current = rated uninterrupted current	$I_n = I_u$	A	800
Rated surge voltage invariability	$U_{imp}$		
Main contacts		V	8000
Auxiliary contacts		V	6000
Rated operational voltage	$U_e$	V AC	690
Overtoltage category/pollution degree			III/3
Rated insulation voltage	$U_i$	V	1000
Use in unearthed supply systems		V	≤ 690

### Switching capacity

Rated short-circuit making capacity	$I_{cm}$		
240 V	$I_{cm}$	kA	275
400/415 V	$I_{cm}$	kA	187
440 V 50/60 Hz	$I_{cm}$	kA	187
525 V 50/60 Hz	$I_{cm}$	kA	143
690 V 50/60 H	$I_c$	kA	100
Rated short-circuit breaking capacity $I_{cn}$	$I_{cn}$		
$I_{cu}$ to IEC/EN 60947 test cycle O-t-CO	$I_{cu}$	kA	
240 V 50/60 Hz	$I_{cu}$	kA	125
400/415 V 50/60 Hz	$I_{cu}$	kA	85
440 V 50/60 Hz	$I_{cu}$	kA	85
525 V 50/60 Hz	$I_{cu}$	kA	65
690 V 50/60 Hz	$I_{cu}$	kA	50
$I_{cs}$ to IEC/EN 60947 test cycle O-t-CO-t-CO	$I_{cs}$	kA	
240 V 50/60 Hz	$I_{cs}$	kA	63
400/415 V 50/60 Hz	$I_{cs}$	kA	50
440 V 50/60 Hz	$I_{cs}$	kA	50
525 V 50/60 Hz	$I_{cs}$	kA	50
690 V 50/60 Hz	$I_{cs}$	kA	37
			Maximum back-up fuse, if the expected short-circuit currents at the installation location exceed the switching capacity of the circuit-breaker.
Rated short-time withstand current			
t = 0.3 s	$I_{cw}$	kA	19.2
t = 1 s	$I_{cw}$	kA	19.2
Utilization category to IEC/EN 60947-2			B
Lifespan, mechanical(of which max. 50 % trip by shunt/undervoltage release)	Operations		10000

Lifespan, electrical			
AC-1			
400 V 50/60 Hz	Operations		3000
415 V 50/60 Hz	Operations		3000
690 V 50/60 Hz	Operations		2000
Max. operating frequency		Ops/h	60
Total break time at short-circuit		ms	< 25 ≤ 415 V; < 35 > 415 V

### Terminal capacity

Standard equipment			Screw connection
Accessories required			NZM4-4-XAVS
Optional accessories			Tunnel terminal connection on rear Strip terminal
Round copper conductor			
Tunnel terminal			
Stranded			
4-hole		mm <sup>2</sup>	4 x (50 - 240)
Bolt terminal and rear-side connection			
Direct on the switch			
Stranded		mm <sup>2</sup>	1 x (120 - 185) 4 x (50 - 185)
Module plate			
Single hole	min.	mm <sup>2</sup>	1 x (120 - 300)
Single hole	max.	mm <sup>2</sup>	2 x (95 - 300)
Module plate			
Double hole	min.	mm <sup>2</sup>	2 x (95 - 185)
Double hole	max.	mm <sup>2</sup>	4 x (35 - 185)
Connection width extension			
Connection width extension		mm <sup>2</sup>	4 x 300 6 x (95 - 240)
Al circular conductor			
Tunnel terminal			
Stranded			
4-hole		mm <sup>2</sup>	4 x (50 - 240)
Cu strip (number of segments x width x segment thickness)			
Flat conductor terminal			
	min.	mm	6 x 16 x 0.8
	max.	mm	(2 x) 10 x 32 x 1.0
Module plate			
Single hole		mm	(2 x) 10 x 50 x 1.0
Bolt terminal and rear-side connection			
Flat copper strip, with holes	min.	mm	5 x 25 x 1.0
Flat copper strip, with holes	max.	mm	(2 x) 10 x 50 x 1.0
Connection width extension		mm	(2 x) 10 x 80 x 1.0
Copper busbar (width x thickness)			
Bolt terminal and rear-side connection			
Screw connection			M10
Direct on the switch			
	min.	mm	25 x 5
	max.	mm	2 x (50 x 10)
Module plate			
Single hole	min.	mm	25 x 5
Single hole	max.	mm	2 x (50 x 10)
Module plate			
Double hole		mm	2 x (50 x 10)
Connection width extension			
		mm	

Connection width extension	min.	mm	60 x 10
Connection width extension	max.	mm	2 x (80 x 10)
Control cables			
		mm <sup>2</sup>	1 x (0.75 - 2.5) 2 x (0.75 - 1.5)

## Design verification as per IEC/EN 61439

Technical data for design verification			
Rated operational current for specified heat dissipation	I <sub>n</sub>	A	800
Equipment heat dissipation, current-dependent	P <sub>vid</sub>	W	79
Operating ambient temperature min.		°C	-25
Operating ambient temperature max.		°C	70
IEC/EN 61439 design verification			
10.2 Strength of materials and parts			
10.2.2 Corrosion resistance			Meets the product standard's requirements.
10.2.3.1 Verification of thermal stability of enclosures			Meets the product standard's requirements.
10.2.3.2 Verification of resistance of insulating materials to normal heat			Meets the product standard's requirements.
10.2.3.3 Verification of resistance of insulating materials to abnormal heat and fire due to internal electric effects			Meets the product standard's requirements.
10.2.4 Resistance to ultra-violet (UV) radiation			Meets the product standard's requirements.
10.2.5 Lifting			Does not apply, since the entire switchgear needs to be evaluated.
10.2.6 Mechanical impact			Does not apply, since the entire switchgear needs to be evaluated.
10.2.7 Inscriptions			Meets the product standard's requirements.
10.3 Degree of protection of ASSEMBLIES			Does not apply, since the entire switchgear needs to be evaluated.
10.4 Clearances and creepage distances			Meets the product standard's requirements.
10.5 Protection against electric shock			Does not apply, since the entire switchgear needs to be evaluated.
10.6 Incorporation of switching devices and components			Does not apply, since the entire switchgear needs to be evaluated.
10.7 Internal electrical circuits and connections			Is the panel builder's responsibility.
10.8 Connections for external conductors			Is the panel builder's responsibility.
10.9 Insulation properties			
10.9.2 Power-frequency electric strength			Is the panel builder's responsibility.
10.9.3 Impulse withstand voltage			Is the panel builder's responsibility.
10.9.4 Testing of enclosures made of insulating material			Is the panel builder's responsibility.
10.10 Temperature rise			The panel builder is responsible for the temperature rise calculation. Eaton will provide heat dissipation data for the devices.
10.11 Short-circuit rating			Is the panel builder's responsibility. The specifications for the switchgear must be observed.
10.12 Electromagnetic compatibility			Is the panel builder's responsibility. The specifications for the switchgear must be observed.
10.13 Mechanical function			The device meets the requirements, provided the information in the instruction leaflet (IL) is observed.

## Technical data ETIM 8.0

Low-voltage industrial components (EG000017) / Power circuit-breaker for trafo/generator/installation protection (EC000228)			
Electric engineering, automation, process control engineering / Low-voltage switch technology / Circuit breaker (LV < 1 kV) / Circuit breaker for power transformer, generator and system protection (ecl@ss10.0.1-27-37-04-09 [AJZ716013])			
Rated permanent current I <sub>u</sub>		A	800
Rated voltage		V	690 - 690
Rated short-circuit breaking capacity I <sub>cu</sub> at 400 V, 50 Hz		kA	50
Overload release current setting		A	320 - 800
Adjustment range short-term delayed short-circuit release		A	2 - 10
Adjustment range undelayed short-circuit release		A	2 - 18
Integrated earth fault protection			No
Type of electrical connection of main circuit			Other
Device construction			Built-in device slide-in technique (withdrawable)
Suitable for DIN rail (top hat rail) mounting			No
DIN rail (top hat rail) mounting optional			No
Number of auxiliary contacts as normally closed contact			0

Number of auxiliary contacts as normally open contact		0
Number of auxiliary contacts as change-over contact		0
With switched-off indicator		No
With integrated under voltage release		No
Number of poles		4
Position of connection for main current circuit		Connection at separate chassis part
Type of control element		Rocker lever
Complete device with protection unit		Yes
Motor drive integrated		No
Motor drive optional		Yes
Degree of protection (IP)		IP20

## Dimensions

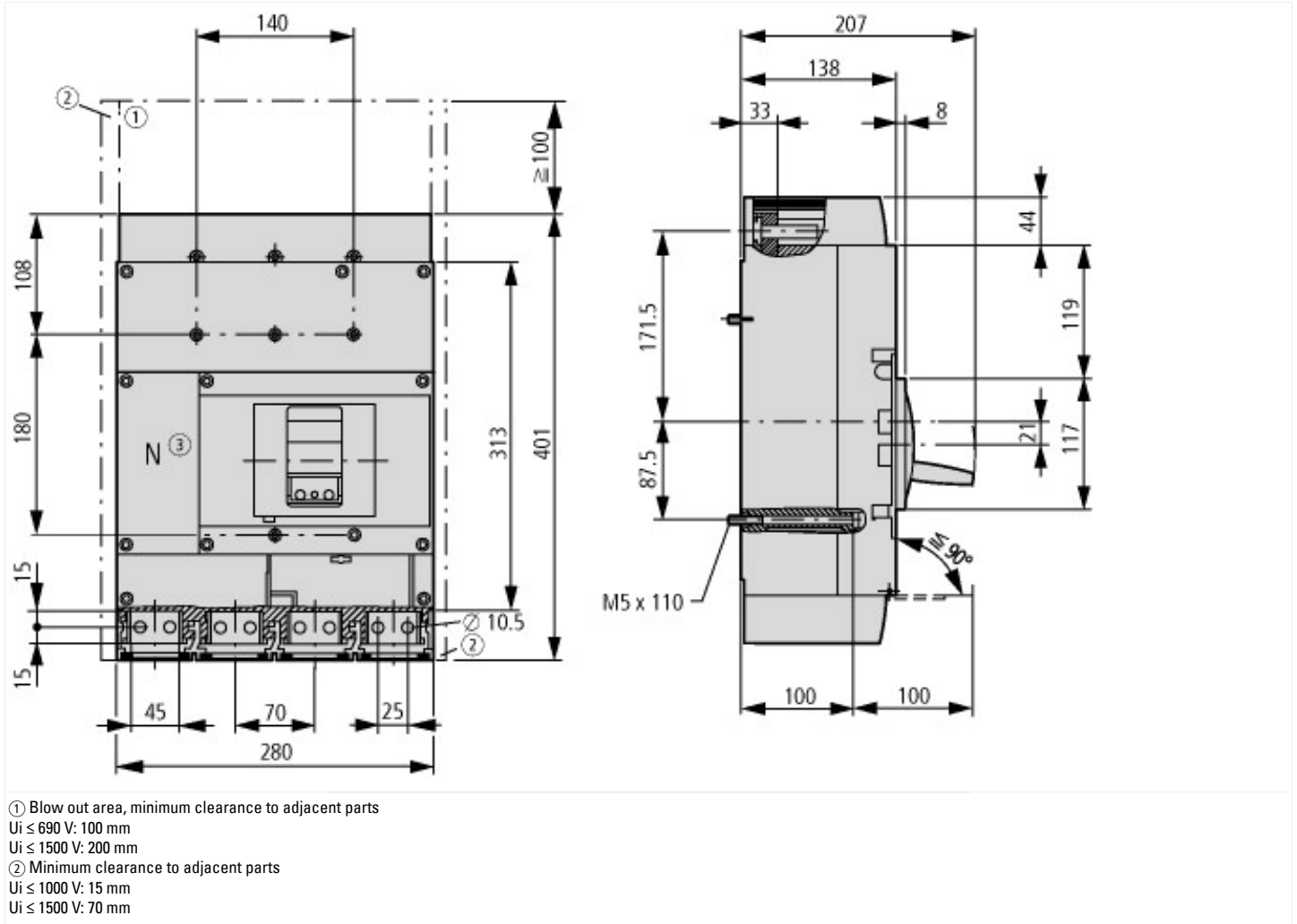

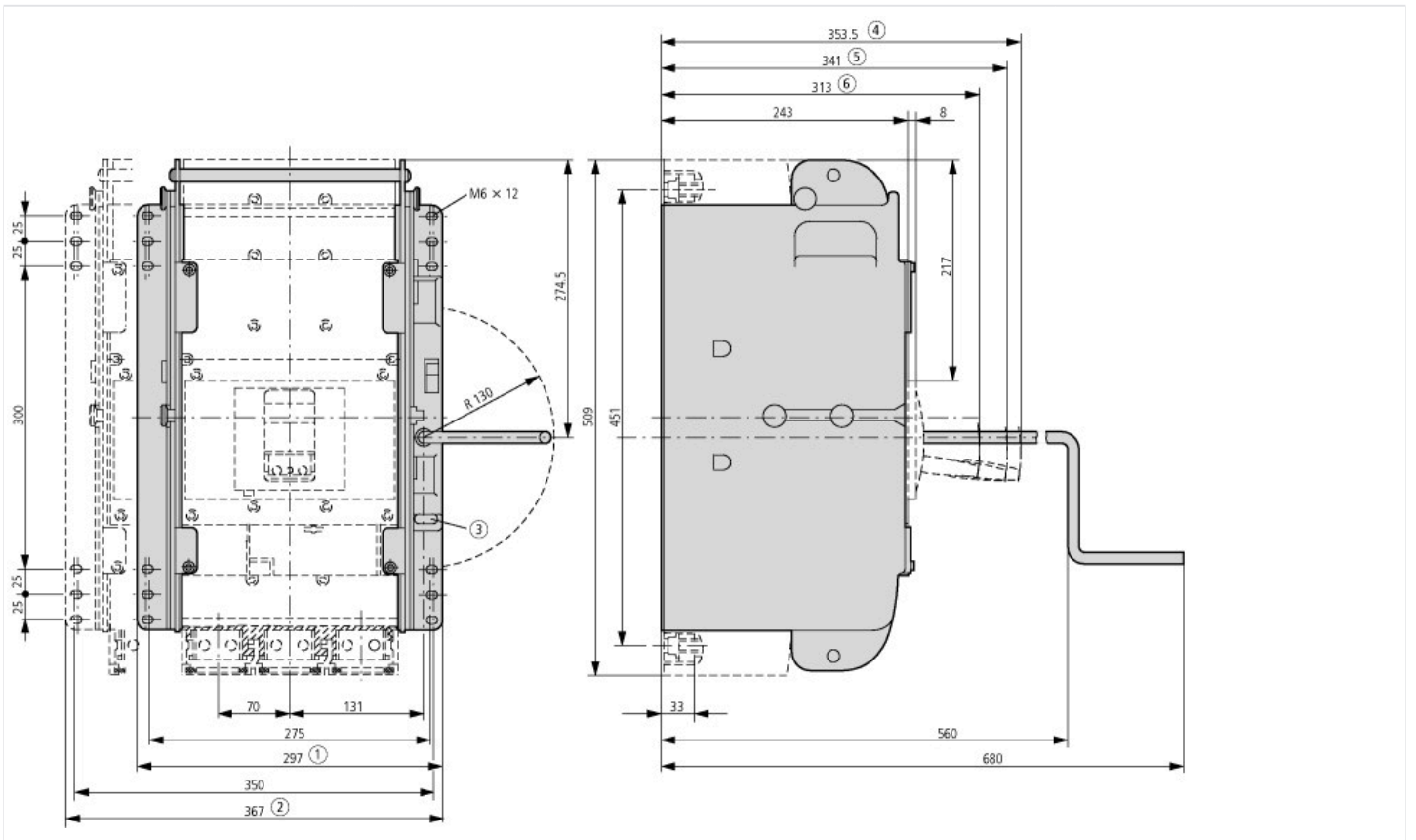

## Additional product information (links)

### IL012101ZU NZM4-PXR circuit-breaker, basic device, NZM4-PXR Circuit-Breaker, basic unit

IL012101ZU NZM4-PXR circuit-breaker, basic device, NZM4-PXR Circuit-Breaker, basic unit [https://es-assets.eaton.com/DOCUMENTATION/AWA\\_INSTRUCTIONS/IL012101ZU2022\\_01.pdf](https://es-assets.eaton.com/DOCUMENTATION/AWA_INSTRUCTIONS/IL012101ZU2022_01.pdf)

Weight <http://ecat.moeller.net/flip-cat/?edition=HPLEN&startpage=17.171>

Temperature dependency, Derating <http://ecat.moeller.net/flip-cat/?edition=HPLEN&startpage=17.172>

Effective power loss <http://ecat.moeller.net/flip-cat/?edition=HPLEN&startpage=17.174>

additional technical information for NZM power switch [https://es-assets.eaton.com/DOCUMENTATION/PDF/nzm\\_technic\\_de\\_en.pdf](https://es-assets.eaton.com/DOCUMENTATION/PDF/nzm_technic_de_en.pdf)