







NZM4 PXR25 circuit breaker - integrated energy measurement class 1, 630A, 4p, variable, Screw terminal, earth-fault protection, ARMS and zone selectivity, withdrawable unit

Part no. NZMN4-4-PX630/VAR-TAZ-AVE
Catalog No. 189671

Delivery program

Product range				Circuit-breaker
Protective function				Systems, cable, selectivity and generator protection Earth-fault protection Zone selectivity ARMS maintenance mode
Standard/Approval				IEC
Installation type				Withdrawable
Release system				Electronic release
Construction size				NZM4
Description				LSIG overload protection and delayed and non-delayed short-circuit protective device, earth-fault protection Class 1 energy measurement, r.m.s. value measurement, and "thermal memory" USB interface for configuration and test function with Power Xpert Protection Manager software Zone selectivity ZSI Maintenance Mode ARMS Interface module in equipment supplied. Optionally communication-capable with internal Modbus RTU module or CAM
Number of poles				4 pole
Standard equipment				Screw connection
Switching capacity				
400/415 V 50 Hz	I_{cu}	kA		50
Rated current = rated uninterrupted current				
Rated current = rated uninterrupted current	$I_n = I_u$	A		630
Neutral conductor	% of phase conductor	%		0 - 60 - 100
Setting range				
Overload trip				
	I_r	A		252 - 630
Short-circuit releases				
				
Non-delayed	$I_i = I_n \times \dots$			2 - 18
				
Delayed	$I_{sd} = I_r \times \dots$			2 - 10
				
Setting range of earth fault release min.	$I_g = I_n \times \dots$			126
Setting range of earth fault release max.	$I_g = I_n \times \dots$			630

Technical data

General				
Standards				IEC/EN 60947
Protection against direct contact				Finger and back of hand proof to VDE 0106 Part 100
Climatic proofing				Damp heat, constant, to IEC 60068-2-78 Damp heat, cyclic, to IEC 60068-2-30
Ambient temperature				
Ambient temperature, storage		°C		- 40 - + 70

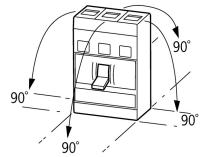
Operation	°C	-25 - +70
Mechanical shock resistance (10 ms half-sinusoidal shock) according to IEC 60068-2-27	g	15 (half-sinusoidal shock 11 ms)
Safe isolation to EN 61140		
Between auxiliary contacts and main contacts	V AC	500
between the auxiliary contacts	V AC	300
Mounting position		Vertical and 90° in all directions  With XFI earth-fault release: - NZM1, N1, NZM2, N2: vertical and 90° in all directions with plug-in unit - NZM1, N1, NZM2, N2: vertical, 90° right/left with withdrawable unit: - NZM3, N3: vertical, 90° right/left - NZM4, N4: vertical with remote operator: - NZM2, N(S)2, NZM3, N(S)3, NZM4, N(S)4: vertical and 90° in all directions
Direction of incoming supply		as required
Degree of protection		
Device		In the operating controls area: IP20 (basic degree of protection)
Enclosures		With insulating surround: IP40 With door coupling rotary handle: IP66
Terminations		Tunnel terminal: IP10 Phase isolator and strip terminal: IP00
Other technical data (sheet catalogue)		Weight Temperature dependency, Derating Effective power loss

Circuit-breakers

Rated current = rated uninterrupted current	$I_n = I_u$	A	630
Rated surge voltage invariability	U_{imp}		
Main contacts		V	8000
Auxiliary contacts		V	6000
Rated operational voltage	U_e	V AC	690
Overtoltage category/pollution degree			III/3
Rated insulation voltage	U_i	V	1000
Use in unearthed supply systems		V	≤ 525

Switching capacity

Rated short-circuit making capacity	I_{cm}		
240 V	I_{cm}	kA	105
400/415 V	I_{cm}	kA	105
440 V 50/60 Hz	I_{cm}	kA	74
525 V 50/60 Hz	I_{cm}	kA	53
690 V 50/60 Hz	I_c	kA	40
Rated short-circuit breaking capacity I_{cn}	I_{cn}		
I_{cu} to IEC/EN 60947 test cycle O-t-CO	I_{cu}	kA	
240 V 50/60 Hz	I_{cu}	kA	50
400/415 V 50/60 Hz	I_{cu}	kA	50
440 V 50/60 Hz	I_{cu}	kA	35
525 V 50/60 Hz	I_{cu}	kA	25
690 V 50/60 Hz	I_{cu}	kA	20
I_{cs} to IEC/EN 60947 test cycle O-t-CO-t-CO	I_{cs}	kA	
240 V 50/60 Hz	I_{cs}	kA	37
400/415 V 50/60 Hz	I_{cs}	kA	37
440 V 50/60 Hz	I_{cs}	kA	26
525 V 50/60 Hz	I_{cs}	kA	19
690 V 50/60 Hz	I_{cs}	kA	15
Rated short-time withstand current			Maximum back-up fuse, if the expected short-circuit currents at the installation location exceed the switching capacity of the circuit-breaker.

t = 0.3 s	I _{cw}	kA	12
t = 1 s	I _{cw}	kA	12
Utilization category to IEC/EN 60947-2			B
Lifespan, mechanical (of which max. 50 % trip by shunt/undervoltage release)	Operations		10000
Lifespan, electrical			
AC-1			
400 V 50/60 Hz	Operations		3000
415 V 50/60 Hz	Operations		3000
690 V 50/60 Hz	Operations		2000
Max. operating frequency		Ops/h	60
Total break time at short-circuit		ms	< 25 ≤ 415 V; < 35 > 415 V

Terminal capacity

Standard equipment			Screw connection
Accessories required			NZM4-4-XAVS
Optional accessories			Tunnel terminal connection on rear Strip terminal
Round copper conductor			
Tunnel terminal			
Stranded			
4-hole		mm ²	4 x (50 - 240)
Bolt terminal and rear-side connection			
Direct on the switch			
Stranded		mm ²	1 x (120 - 185) 4 x (50 - 185)
Module plate			
Single hole	min.	mm ²	1 x (120 - 300)
Single hole	max.	mm ²	2 x (95 - 300)
Module plate			
Double hole	min.	mm ²	2 x (95 - 185)
Double hole	max.	mm ²	4 x (35 - 185)
Connection width extension		mm ²	
Connection width extension		mm ²	4 x 300 6 x (95 - 240)
Al circular conductor			
Tunnel terminal			
Stranded			
4-hole		mm ²	4 x (50 - 240)
Cu strip (number of segments x width x segment thickness)			
Flat conductor terminal			
	min.	mm	6 x 16 x 0.8
	max.	mm	(2 x) 10 x 32 x 1.0
Module plate			
Single hole		mm	(2 x) 10 x 50 x 1.0
Bolt terminal and rear-side connection			
Flat copper strip, with holes	min.	mm	5 x 25 x 1.0
Flat copper strip, with holes	max.	mm	(2 x) 10 x 50 x 1.0
Connection width extension		mm	(2 x) 10 x 80 x 1.0
Copper busbar (width x thickness)	mm		
Bolt terminal and rear-side connection			
Screw connection			M10
Direct on the switch			
	min.	mm	25 x 5
	max.	mm	2 x (50 x 10)
Module plate			
Single hole	min.	mm	25 x 5

Single hole	max.	mm	2 x (50 x 10)
Module plate			
Double hole		mm	2 x (50 x 10)
Connection width extension		mm	
Connection width extension	min.	mm	60 x 10
Connection width extension	max.	mm	2 x (80 x 10)
Control cables			
		mm ²	1 x (0.75 - 2.5) 2 x (0.75 - 1.5)

Design verification as per IEC/EN 61439

Technical data for design verification			
Rated operational current for specified heat dissipation	I _n	A	630
Equipment heat dissipation, current-dependent	P _{vid}	W	65
Operating ambient temperature min.		°C	-25
Operating ambient temperature max.		°C	70
IEC/EN 61439 design verification			
10.2 Strength of materials and parts			
10.2.2 Corrosion resistance			Meets the product standard's requirements.
10.2.3.1 Verification of thermal stability of enclosures			Meets the product standard's requirements.
10.2.3.2 Verification of resistance of insulating materials to normal heat			Meets the product standard's requirements.
10.2.3.3 Verification of resistance of insulating materials to abnormal heat and fire due to internal electric effects			Meets the product standard's requirements.
10.2.4 Resistance to ultra-violet (UV) radiation			Meets the product standard's requirements.
10.2.5 Lifting			Does not apply, since the entire switchgear needs to be evaluated.
10.2.6 Mechanical impact			Does not apply, since the entire switchgear needs to be evaluated.
10.2.7 Inscriptions			Meets the product standard's requirements.
10.3 Degree of protection of ASSEMBLIES			Does not apply, since the entire switchgear needs to be evaluated.
10.4 Clearances and creepage distances			Meets the product standard's requirements.
10.5 Protection against electric shock			Does not apply, since the entire switchgear needs to be evaluated.
10.6 Incorporation of switching devices and components			Does not apply, since the entire switchgear needs to be evaluated.
10.7 Internal electrical circuits and connections			Is the panel builder's responsibility.
10.8 Connections for external conductors			Is the panel builder's responsibility.
10.9 Insulation properties			
10.9.2 Power-frequency electric strength			Is the panel builder's responsibility.
10.9.3 Impulse withstand voltage			Is the panel builder's responsibility.
10.9.4 Testing of enclosures made of insulating material			Is the panel builder's responsibility.
10.10 Temperature rise			The panel builder is responsible for the temperature rise calculation. Eaton will provide heat dissipation data for the devices.
10.11 Short-circuit rating			Is the panel builder's responsibility. The specifications for the switchgear must be observed.
10.12 Electromagnetic compatibility			Is the panel builder's responsibility. The specifications for the switchgear must be observed.
10.13 Mechanical function			The device meets the requirements, provided the information in the instruction leaflet (IL) is observed.

Technical data ETIM 8.0

Low-voltage industrial components (EG000017) / Power circuit-breaker for trafo/generator/installation protection (EC000228)			
Electric engineering, automation, process control engineering / Low-voltage switch technology / Circuit breaker (LV < 1 kV) / Circuit breaker for power transformer, generator and system protection (ec@ss10.0.1-27-37-04-09 [AJZ716013])			
Rated permanent current I _u		A	630
Rated voltage		V	690 - 690
Rated short-circuit breaking capacity I _{cu} at 400 V, 50 Hz		kA	37
Overload release current setting		A	252 - 630
Adjustment range short-term delayed short-circuit release		A	2 - 10
Adjustment range undelayed short-circuit release		A	1260 - 22680
Integrated earth fault protection			Yes
Type of electrical connection of main circuit			Other

Device construction		Built-in device slide-in technique (withdrawable)
Suitable for DIN rail (top hat rail) mounting		No
DIN rail (top hat rail) mounting optional		No
Number of auxiliary contacts as normally closed contact		0
Number of auxiliary contacts as normally open contact		0
Number of auxiliary contacts as change-over contact		0
With switched-off indicator		No
With integrated under voltage release		No
Number of poles		4
Position of connection for main current circuit		Connection at separate chassis part
Type of control element		Rocker lever
Complete device with protection unit		Yes
Motor drive integrated		No
Motor drive optional		Yes
Degree of protection (IP)		IP20

Dimensions

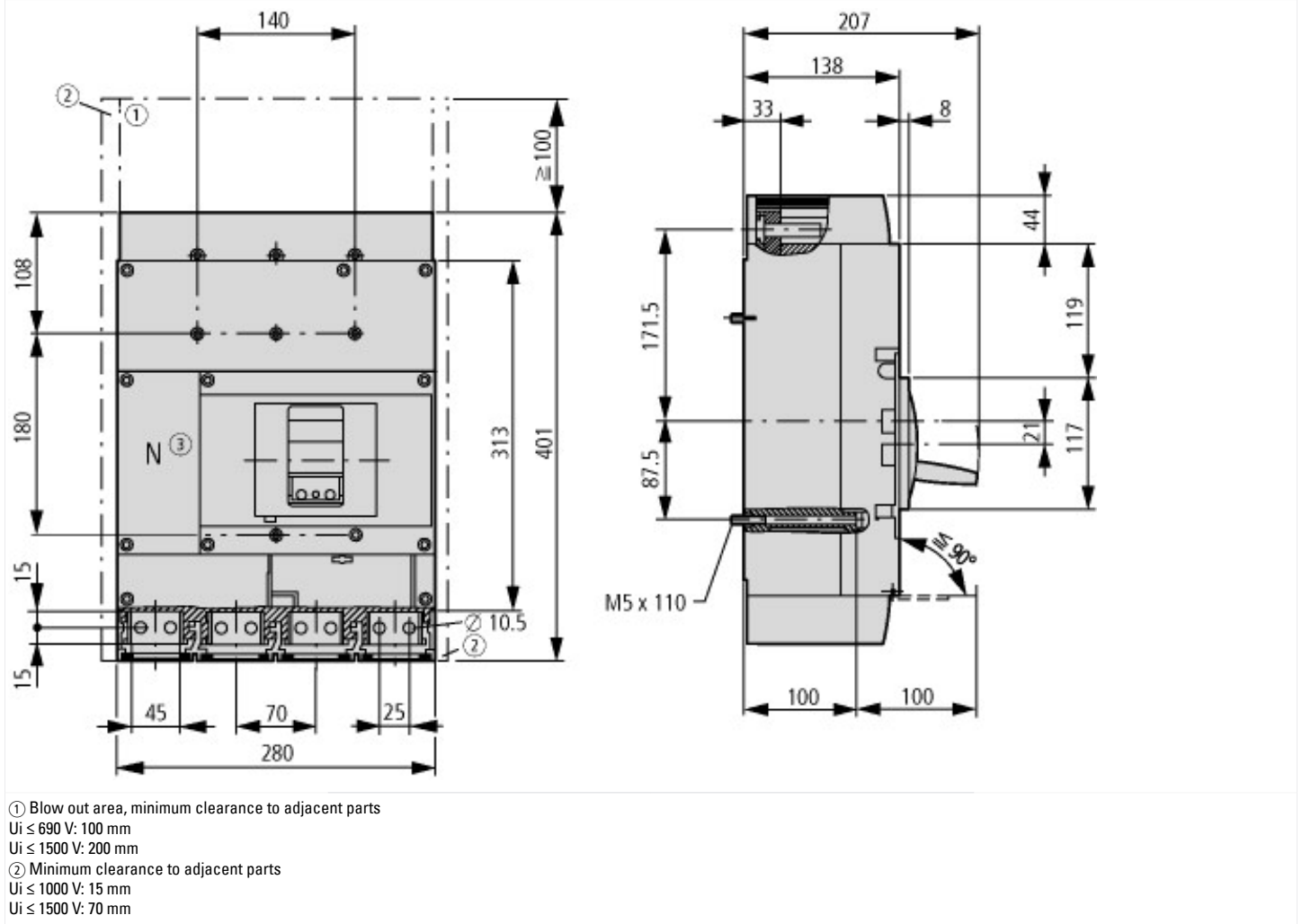

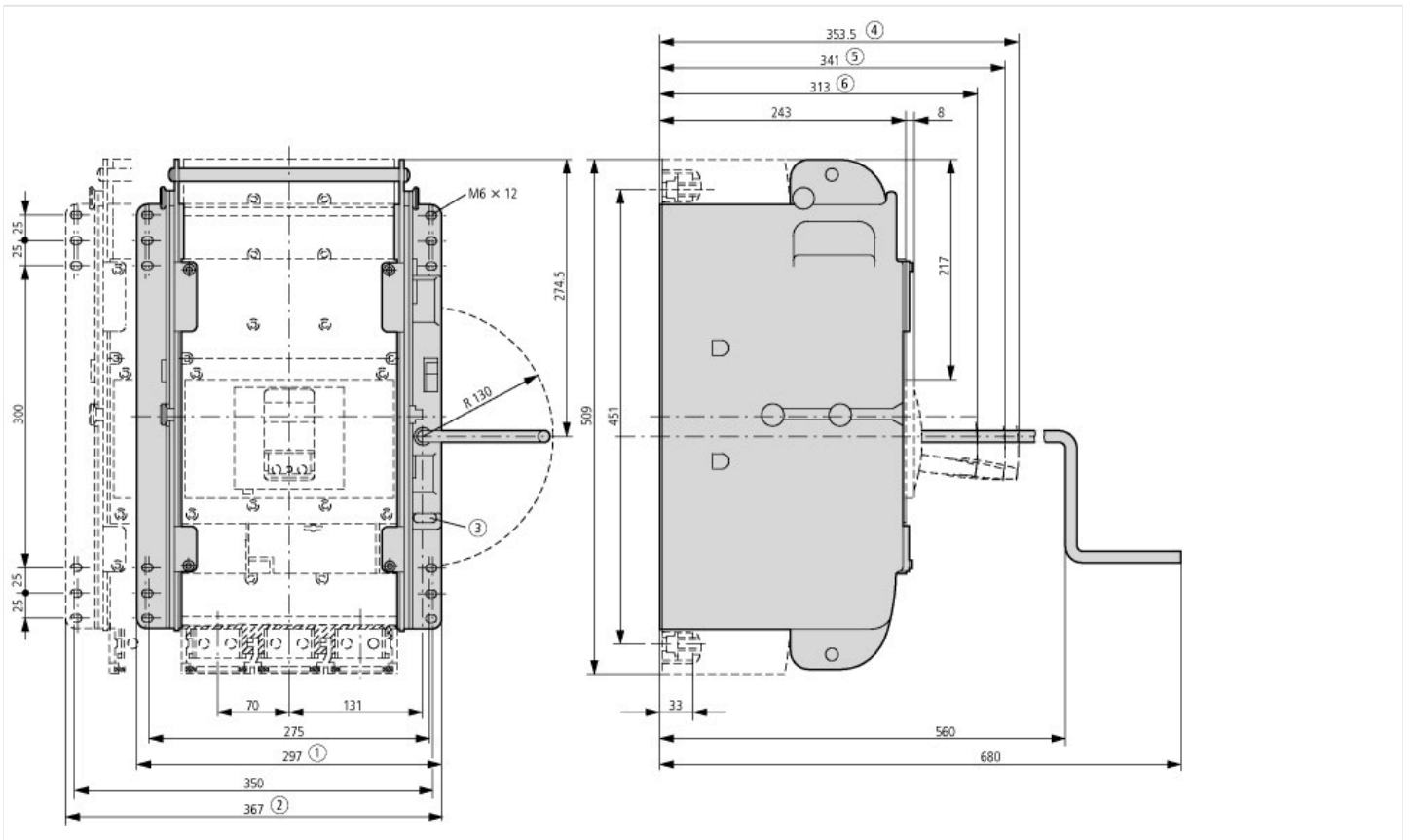

Additional product information (links)

IL012101ZU NZM4-PXR circuit-breaker, basic device, NZM4-PXR Circuit-Breaker, basic unit

IL012101ZU NZM4-PXR circuit-breaker, basic device, NZM4-PXR Circuit-Breaker, basic unit	https://es-assets.eaton.com/DOCUMENTATION/AWA_INSTRUCTIONS/IL012101ZU2022_01.pdf
Weight	http://ecat.moeller.net/flip-cat/?edition=HPLEN&startpage=17.171
Temperature dependency, Derating	http://ecat.moeller.net/flip-cat/?edition=HPLEN&startpage=17.172
Effective power loss	http://ecat.moeller.net/flip-cat/?edition=HPLEN&startpage=17.174
additional technical information for NZM power switch	https://es-assets.eaton.com/DOCUMENTATION/PDF/nzm_technic_de_en.pdf