







Circuit-breaker, 3p, 220A

Part no. **NZML3-ME220**  
 Catalog No. **265797**  
 Alternate Catalog No. **NZML3-ME220**

## Delivery program

Product range				Circuit-breaker
Protective function				Motor protection
				
Standard/Approval				IEC
Installation type				Fixed
Release system				Electronic release
Construction size				NZM3
Description				IEC/EN 60947-4-1, IEC/EN 60947-2  The circuit-breaker fulfills all requirements for AC-3 switching category.  R.m.s. value measurement and "thermal memory" Adjustable time delay setting to overcome current peaks $t_r$ at $6 \times I_r$ also infinity (without overload releases) All AC-3 rating data applies to direct switching by the circuit-breaker under normal operating conditions. If, for example, a contactor takes over AC-3 switching under normal operating conditions, the full rated uninterrupted current applies to the circuit-breaker, $I_n = I_u$ .
Number of poles				3 pole
Standard equipment				Screw connection
<b>Switching capacity</b>				
400/415 V 50 Hz	$I_{cu}$	kA		150
Rated current = rated uninterrupted current	$I_n = I_u$	A		220
<b>Setting range</b>				
Overload trip				
	$I_r$	A		110 - 220
Short-circuit releases				
				
Non-delayed	$I_i = I_n \times \dots$			2 - 14
				
<b>Motor rating AC-3 50/60 Hz</b>				
380 V 400 V	P	kW		110
660 V 690 V	P	kW		200
<b>Motor rating AC-3 50/60 Hz</b>				
400 V	P	kW		110
660 V 690 V	P	kW		200
<b>Rated operational current AC-3 50/60 Hz</b>				
400 V	$I_e$	A		196
690 V		A		202

## Technical data

<b>General</b>			
Standards			IEC/EN 60947

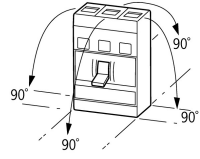
Protection against direct contact			Finger and back of hand proof to VDE 0106 Part 100
Climatic proofing			Damp heat, constant, to IEC 60068-2-78 Damp heat, cyclic, to IEC 60068-2-30
Ambient temperature			
Ambient temperature, storage	°C		- 40 - + 70
Operation	°C		-25 - +70
Mechanical shock resistance (10 ms half-sinusoidal shock) according to IEC 60068-2-27	g		20 (half-sinusoidal shock 20 ms)
Safe isolation to EN 61140			
Between auxiliary contacts and main contacts	V AC		500
between the auxiliary contacts	V AC		300
Mounting position			Vertical and 90° in all directions  With XFI earth-fault release: - NZM1, N1, NZM2, N2: vertical and 90° in all directions with plug-in unit - NZM1, N1, NZM2, N2: vertical, 90° right/left with withdrawable unit: - NZM3, N3: vertical, 90° right/left - NZM4, N4: vertical with remote operator: - NZM2, N(S)2, NZM3, N(S)3, NZM4, N(S)4: vertical and 90° in all directions
Direction of incoming supply			as required
Degree of protection			
Device			In the operating controls area: IP20 (basic degree of protection)
Enclosures			With insulating surround: IP40 With door coupling rotary handle: IP66
Terminations			Tunnel terminal: IP10 Phase isolator and strip terminal: IP00
Other technical data (sheet catalogue)			Temperature dependency, Derating

### Circuit-breakers

Rated current = rated uninterrupted current	$I_n = I_u$	A	220
Rated surge voltage invariability	$U_{imp}$		
Main contacts		V	8000
Auxiliary contacts		V	6000
Rated operational voltage	$U_e$	V AC	690
Overvoltage category/pollution degree			III/3
Rated insulation voltage	$U_i$	V	1000
Use in unearthed supply systems		V	≤ 690

### Switching capacity

Rated short-circuit making capacity	$I_{cm}$		
240 V	$I_{cm}$	kA	330
400/415 V	$I_{cm}$	kA	330
440 V 50/60 Hz	$I_{cm}$	kA	286
525 V 50/60 Hz	$I_{cm}$	kA	220
690 V 50/60 H	$I_c$	kA	176
Rated short-circuit breaking capacity $I_{cn}$	$I_{cn}$		
$I_{cu}$ to IEC/EN 60947 test cycle O-t-CO	$I_{cu}$	kA	
240 V 50/60 Hz	$I_{cu}$	kA	150
400/415 V 50/60 Hz	$I_{cu}$	kA	150
440 V 50/60 Hz	$I_{cu}$	kA	130
525 V 50/60 Hz	$I_{cu}$	kA	100
690 V 50/60 Hz	$I_{cu}$	kA	80
$I_{cs}$ to IEC/EN 60947 test cycle O-t-CO-t-CO	$I_{cs}$	kA	
240 V 50/60 Hz	$I_{cs}$	kA	150
400/415 V 50/60 Hz	$I_{cs}$	kA	150
440 V 50/60 Hz	$I_{cs}$	kA	130
525 V 50/60 Hz	$I_{cs}$	kA	50

690 V 50/60 Hz	$I_{cs}$	kA	20
			Maximum back-up fuse, if the expected short-circuit currents at the installation location exceed the switching capacity of the circuit-breaker.
Rated short-time withstand current			
t = 0.3 s	$I_{cw}$	kA	2.8
t = 1 s	$I_{cw}$	kA	2.8
Utilization category to IEC/EN 60947-2			A
Lifespan, mechanical(of which max. 50 % trip by shunt/undervoltage release)			Operations
Lifespan, electrical			10000
AC-1			
400 V 50/60 Hz	Operations		5000
415 V 50/60 Hz	Operations		5000
690 V 50/60 Hz	Operations		3000
AC--3			
400 V 50/60 Hz	Operations		2000
415 V 50/60 Hz	Operations		2000
690 V 50/60 Hz	Operations		2000
Max. operating frequency		Ops/h	60
Total break time at short-circuit		ms	< 10

### Terminal capacity

Standard equipment			Screw connection
Optional accessories			Box terminal Tunnel terminal connection on rear
Round copper conductor			
Box terminal			
Solid		mm <sup>2</sup>	2 x 16
Stranded		mm <sup>2</sup>	1 x (35 - 240) 2 x (25-120)
Tunnel terminal			
Solid		mm <sup>2</sup>	1 x 16
Stranded			
1-hole		mm <sup>2</sup>	1 x (16 - 185)
Double hole fitting		mm <sup>2</sup>	2 x (50 - 240)
Bolt terminal and rear-side connection			
Direct on the switch			
Solid		mm <sup>2</sup>	1 x 16 2 x 16
Stranded		mm <sup>2</sup>	1 x (25 - 240) 2 x (25 - 240)
Connection width extension		mm <sup>2</sup>	
Connection width extension		mm <sup>2</sup>	2 x 300
Al circular conductor			
Tunnel terminal			
Solid		mm <sup>2</sup>	1 x 16
Stranded			
Stranded		mm <sup>2</sup>	1 x (25 - 185) <sup>2)</sup>
Double hole		mm <sup>2</sup>	1 x (50 - 240) 2 x (50 - 240)
			<sup>2)</sup> Up to 240 mm <sup>2</sup> can be connected depending on the cable manufacturer.
Bolt terminal and rear-side connection			
Direct on the switch			
Solid		mm <sup>2</sup>	1 x 16 2 x (10 - 16)
Stranded		mm <sup>2</sup>	1 x (25 - 120) 2 x (25 - 120)
Cu strip (number of segments x width x segment thickness)			

Box terminal			
	min.	mm	6 x 16 x 0.8
	max.	mm	10 x 24 x 1.0 + 5 x 24 x 1.0 (2 x) 8 x 24 x 1.0
Bolt terminal and rear-side connection			
Flat copper strip, with holes	min.	mm	6 x 16 x 0.8
Flat copper strip, with holes	max.	mm	10 x 32 x 1.0 + 5 x 32 x 1.0
Connection width extension		mm	(2 x) 10 x 50 x 1.0
Copper busbar (width x thickness)	mm		
Bolt terminal and rear-side connection			
Screw connection			M10
Direct on the switch			
	min.	mm	20 x 5
	max.	mm	30 x 10 + 30 x 5
Connection width extension		mm	
Connection width extension	max.	mm	2 x (10 x 50)
Control cables			
		mm <sup>2</sup>	1 x (0.75 - 2.5) 2 x (0.75 - 1.5)

## Design verification as per IEC/EN 61439

Technical data for design verification			
Rated operational current for specified heat dissipation	I <sub>n</sub>	A	220
Equipment heat dissipation, current-dependent	P <sub>vid</sub>	W	14.52
Operating ambient temperature min.		°C	-25
Operating ambient temperature max.		°C	70
IEC/EN 61439 design verification			
10.2 Strength of materials and parts			
10.2.2 Corrosion resistance			Meets the product standard's requirements.
10.2.3.1 Verification of thermal stability of enclosures			Meets the product standard's requirements.
10.2.3.2 Verification of resistance of insulating materials to normal heat			Meets the product standard's requirements.
10.2.3.3 Verification of resistance of insulating materials to abnormal heat and fire due to internal electric effects			Meets the product standard's requirements.
10.2.4 Resistance to ultra-violet (UV) radiation			Meets the product standard's requirements.
10.2.5 Lifting			Does not apply, since the entire switchgear needs to be evaluated.
10.2.6 Mechanical impact			Does not apply, since the entire switchgear needs to be evaluated.
10.2.7 Inscriptions			Meets the product standard's requirements.
10.3 Degree of protection of ASSEMBLIES			Does not apply, since the entire switchgear needs to be evaluated.
10.4 Clearances and creepage distances			Meets the product standard's requirements.
10.5 Protection against electric shock			Does not apply, since the entire switchgear needs to be evaluated.
10.6 Incorporation of switching devices and components			Does not apply, since the entire switchgear needs to be evaluated.
10.7 Internal electrical circuits and connections			Is the panel builder's responsibility.
10.8 Connections for external conductors			Is the panel builder's responsibility.
10.9 Insulation properties			
10.9.2 Power-frequency electric strength			Is the panel builder's responsibility.
10.9.3 Impulse withstand voltage			Is the panel builder's responsibility.
10.9.4 Testing of enclosures made of insulating material			Is the panel builder's responsibility.
10.10 Temperature rise			The panel builder is responsible for the temperature rise calculation. Eaton will provide heat dissipation data for the devices.
10.11 Short-circuit rating			Is the panel builder's responsibility. The specifications for the switchgear must be observed.
10.12 Electromagnetic compatibility			Is the panel builder's responsibility. The specifications for the switchgear must be observed.
10.13 Mechanical function			The device meets the requirements, provided the information in the instruction leaflet (IL) is observed.

## Technical data ETIM 7.0

Low-voltage industrial components (EG000017) / Motor protection circuit-breaker (EC000074)

Electric engineering, automation, process control engineering / Low-voltage switch technology / Circuit breaker (LV < 1 kV) / Motor protection circuit-breaker (ecl@ss10.0.1-27-37-04-01 [AGZ529016])

Overload release current setting	A	110 - 220
Adjustment range undelayed short-circuit release	A	440 - 3080
With thermal protection		Yes
Phase failure sensitive		Yes
Switch off technique		Electronic
Rated operating voltage	V	690 - 690
Rated permanent current I <sub>u</sub>	A	220
Rated operation power at AC-3, 230 V	kW	55
Rated operation power at AC-3, 400 V	kW	110
Type of electrical connection of main circuit		Screw connection
Type of control element		Rocker lever
Device construction		Built-in device fixed built-in technique
With integrated auxiliary switch		No
With integrated under voltage release		No
Number of poles		3
Rated short-circuit breaking capacity I <sub>cu</sub> at 400 V, AC	kA	150
Degree of protection (IP)		IP20
Height	mm	275
Width	mm	140
Depth	mm	166

# Characteristics

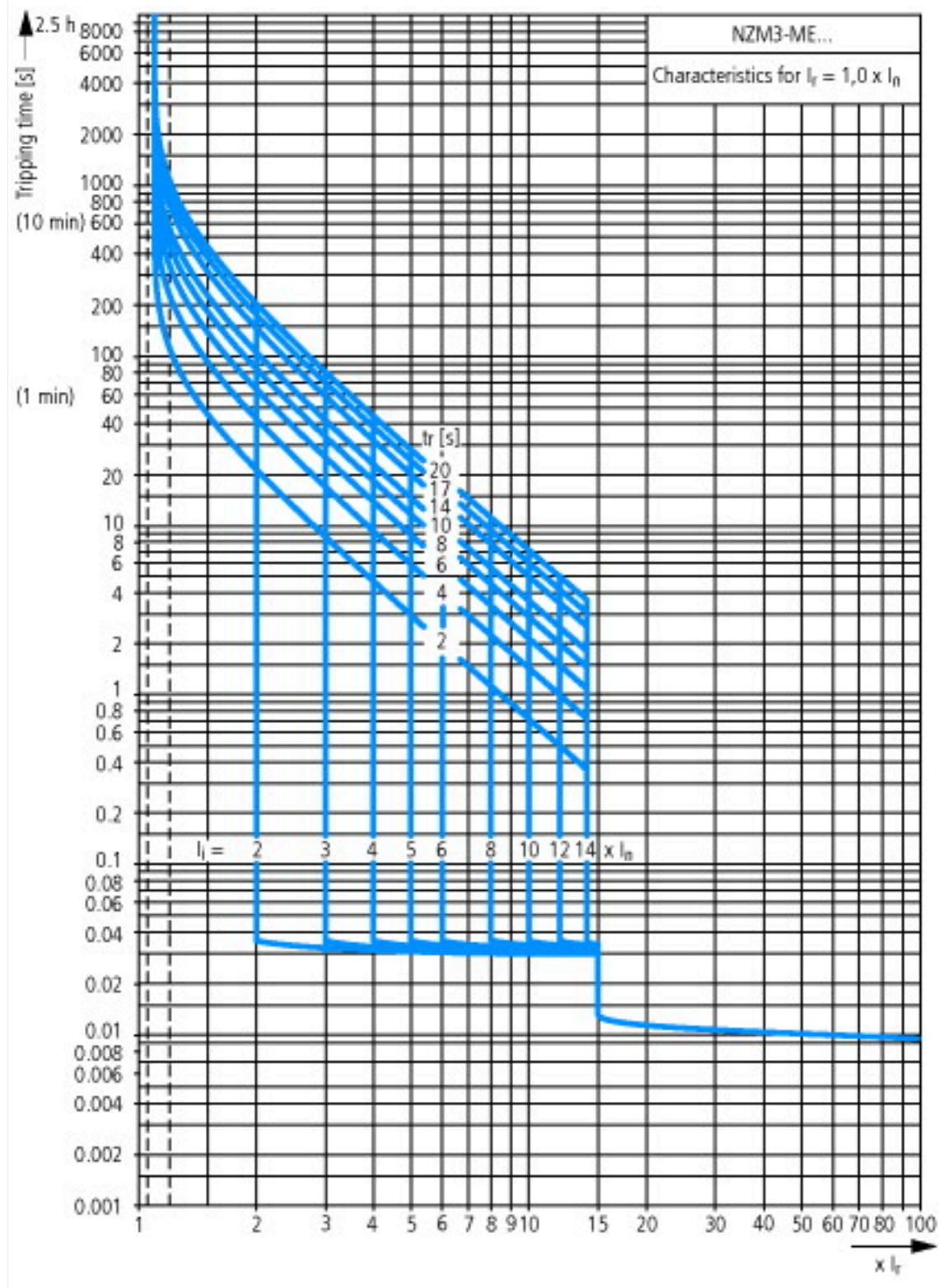

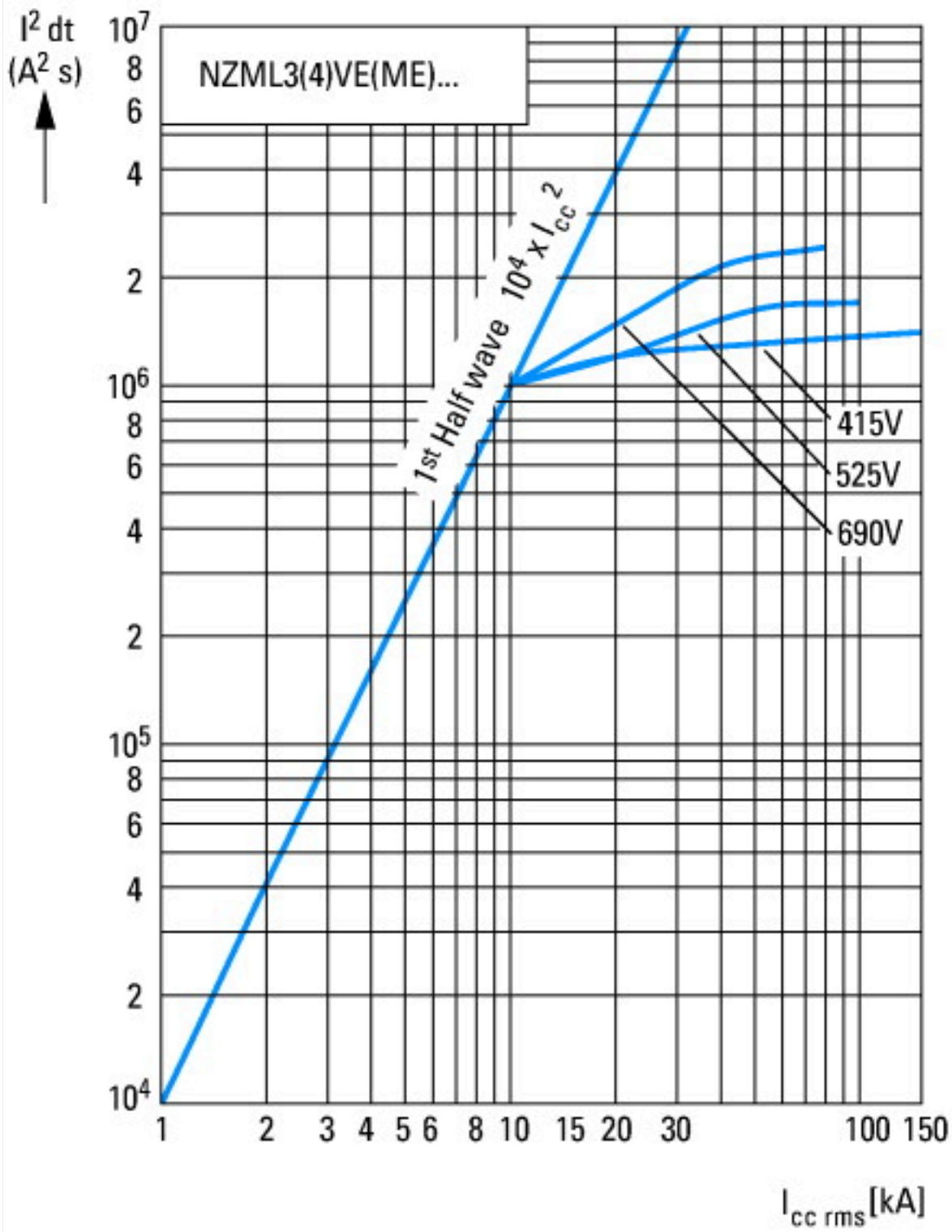

Let-through current

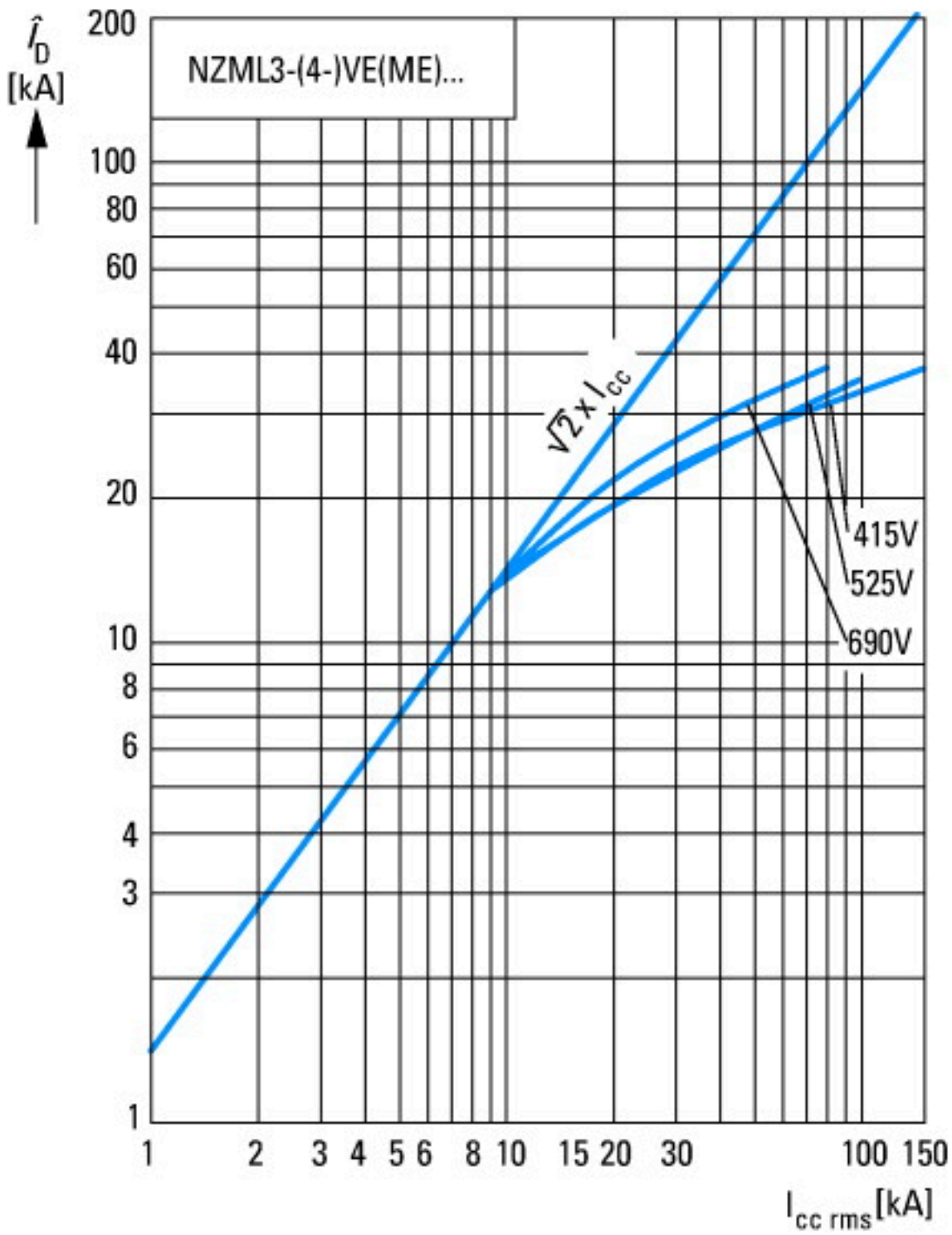

Let-through energy



## Dimensions

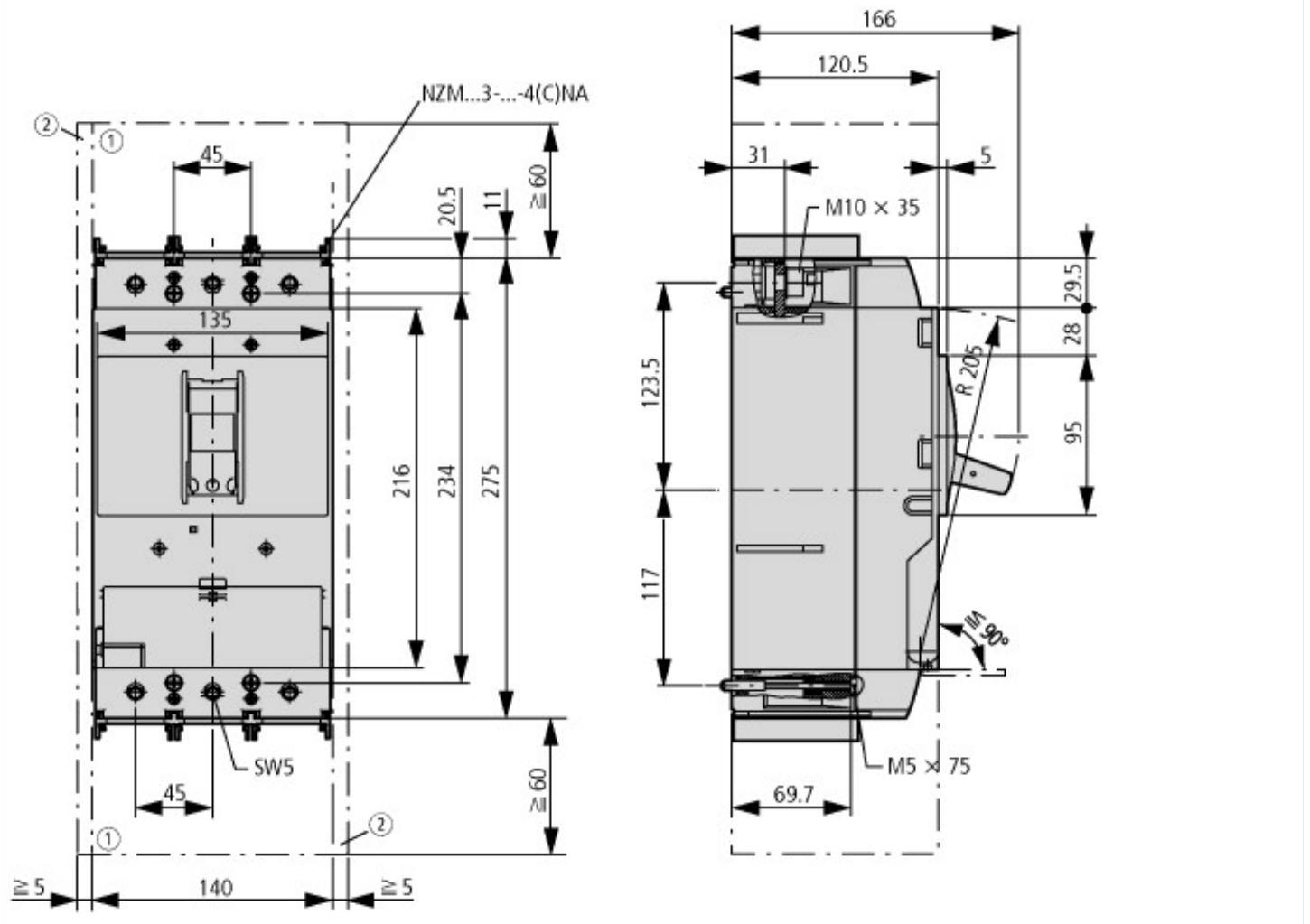

- ① Blow out area, minimum clearance to adjacent parts  
 ② Minimum clearance to adjacent parts



### Additional product information (links)

Temperature dependency, Derating

<http://ecat.moeller.net/flip-cat/?edition=HPLEN&startpage=17.172>

additional technical information for NZM power switch

[https://es-assets.eaton.com/DOCUMENTATION/PDF/nzm\\_technic\\_de\\_en.pdf](https://es-assets.eaton.com/DOCUMENTATION/PDF/nzm_technic_de_en.pdf)