

**M12 FEMALE 0° SHIELDED**

PUR 4X0.34 shielded GRAY, UL/CSA 2m

Female straight

M12, 4-pole

shielded

with cable sleeves

Plastic housings with good resistance against chemicals and oils.

The resistance to aggressive media should be individually tested for your application. Further details on request.

Further cable lengths on request.

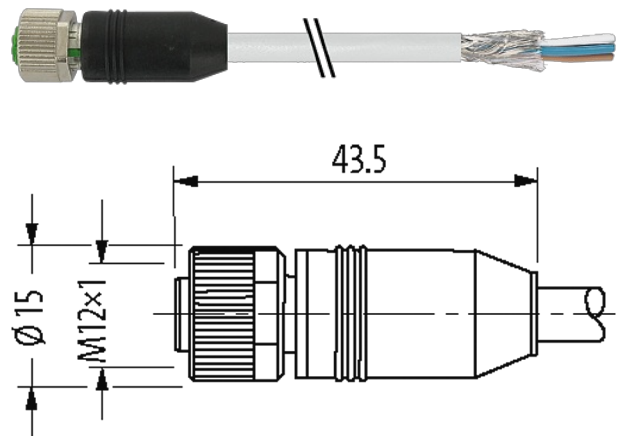
**[Link to Product](#)****Illustration**

Product may differ from Image

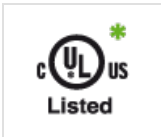
**Approvals**

\* only for products with UL/CSA approved cable

cCSAus

EAC

**Form**

Form 13201

**Technical Data**

Operating voltage	max. 60 V AC/DC
Operating voltage (only UL listed)	max. 30 V AC/DC
Operating current per contact	max. 4 A
Rated surge voltage	1.5 kV
Material group	IEC 60664-1, category I
Coding	A-coded
Locking of ports	Screw thread (M12×1 mm) recommended torque 0.6 Nm, self-securing
Compression gland	M12 (SW13)
Protection	IP65, IP66K, IP67 inserted and tightened (EN 60529)
Locking material	Zinc die casting, matte nickel plated
Material	PUR

**General data**

Standards	DIN EN 61076-2-101 (M12)
Pollution Degree	3
Temperature range	-25...+85 °C, depending on cable quality

**Cables**

No./diameter of wires	4× 0.34 mm <sup>2</sup>
Wire isolation	PP (br, wh, bl, bk)
Material (jacket)	PUR (UL/CSA)
Outer Ø	5.9 mm ±5%
Bend radius (moving)	10× outer Ø
Temperature range (fixed)	-40...+80 °C
Temperature range (mobile)	-20...+80 °C
Cable identification	335
Cable Type	PUR-OB
Approval (cable)	UL (AWM-Style 20233/1992), CSA; CE conform
Cable weight [g/m]	56,10
Material (wire)	Cu wire, bare
Resistor (core)	max. 52 Ω/km (20 °C)
Single wire Ø (core)	0.1 mm
Diameter (core)	4× 0.34 mm <sup>2</sup>
Material (wire isolation)	PP
Material property (wire isolation)	CFC-, halogen-, cadmium-, silicone- and lead-free
Shore hardness (wire isolation)	72 ±3 D
Wire-Ø incl. isolation	1.55 mm ±5%
Color/numbering of wires	br, bk, bl, wh
Stranding combination	4 wires twisted
Shield	yes
optical shield cover	min. 85%
Material (jacket)	PUR
Shore hardness (jacket)	85 ±3 A
Outer-Ø (jacket)	5.9 mm ±5%
Color (jacket)	gray
chemical resistance	good resistance to oil, gasoline and chemicals (VDE 0472 Teil 803 Test B)
thermal resistance	flame retardant UL VW1, CSA FT1
Nominal voltage	300 V AC
Test voltage	2000 V AC
Temperature range (fixed)	-40...+80 °C
Temperature range (mobile)	-20...+80 °C
Bend radius (fixed)	10× outer Ø
Jacket Color	gray

**Commercial data**

country of origin	DE
customs tariff number	85444290
EAN	4048879200011
eClass	27279218
Packaging unit	1

**Sketch**

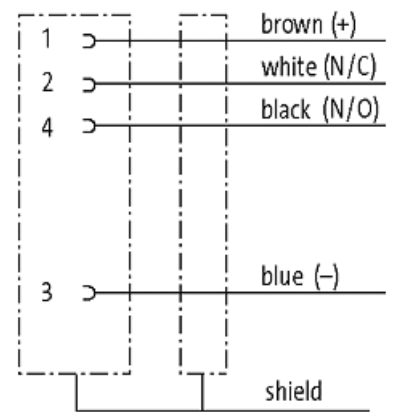

## Female

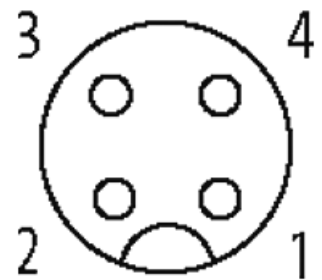

Product may differ from Image