

M12 MALE 0° / M12 FEMALE 0°

PUR 3X0.34 GRAY, UL/CSA, drag ch 0.6m

Male straight – female straight

M12 – M12, 3-pole

Art-No. 7005 - M12 Lite - (plastic hexagonal screw) on request

Plastic housings with good resistance against chemicals and oils.

The resistance to aggressive media should be individually tested for your application. Further details on request.

Further cable lengths on request.

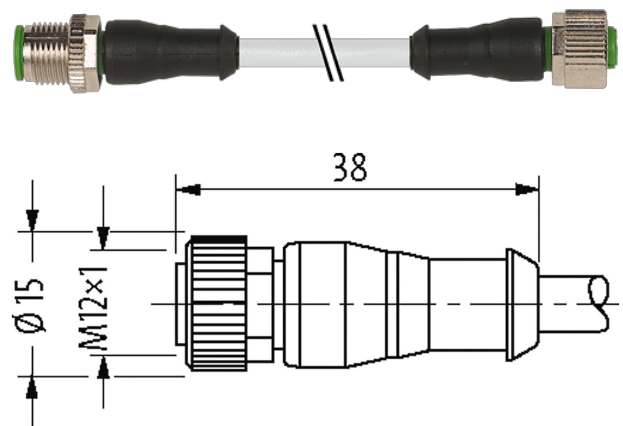
Link to Product**Illustration**

Product may differ from Image

Approvals

* only for products with UL/CSA approved cable

cCSAus

Form

Form 40001

Technical Data

Operating voltage	max. 250 V AC/DC
Operating voltage (only UL listed)	max. 30 V AC/DC
Rated surge voltage	2.5 kV
Operating current per contact	max. 4 A
Material group	IEC 60664-1, category I
No. of poles	3
Coding	A-coded
Locking of ports	Screw thread (M12×1 mm) recommended torque 0.6 Nm, self-securing
Compression gland	M12 (SW13)
Protection	IP65, IP66K, IP67 inserted and tightened (EN 60529)
Locking material	Zinc die casting, matte nickel plated
Material	PUR
suitable for corrugated tube (internal Ø)	10 mm

General data

The information in this brochure has been compiled with the utmost care.

Liability for the correctness completeness and topicality of the information is restricted to gross negligence. Version: 02/21

Murrelektronik GmbH | Falkenstr. 3 | 71570 Oppenweiler | Fon +49 (71 91) 47-0 | Fax +49 (71 91) 47-491000 | shop@murrelektronik.com | shop.murrelektronik.com

Standards	DIN EN 61076-2-101 (M12)
Mounting method	inserted, tightened
Pollution Degree	3
Temperature range	-25...+85 °C, depending on cable quality
Cables	
No./diameter of wires	3× 0.34 mm ²
C-track properties	10 Mio.
Wire isolation	PP (br, bl, bk)
Material (jacket)	PUR (UL/CSA)
Outer Ø	4.1 mm ±5%
Bend radius (moving)	10× outer Ø
Temperature range (fixed)	-40...+80 °C
Temperature range (mobile)	-25...+80 °C
Cable identification	233
Cable Type	3 (PUR)
Approval (cable)	cURus (AWM-Style 20549/10493); CE conform
Cable weight [g/m]	29,70
Material (wire)	Cu wire, bare
Resistor (core)	max. 57 Ω/km (20 °C)
Single wire Ø (core)	0.1 mm
Construction (core)	42× 0.1 mm (multi-strand wire class 6)
Diameter (core)	3× 0.34 mm ²
AWG	similar to AWG 22
Material (wire isolation)	PP
Material property (wire isolation)	CFC-, halogen-, cadmium-, silicone- and lead-free
Shore hardness (wire isolation)	70 ±5 D
Wire-Ø incl. isolation	1.25 mm ±5%
Color/numbering of wires	br, bk, bl
Stranding combination	3 wires twisted
Shield	no
Material (jacket)	PUR
Material property (jacket)	CFC-, halogen-, cadmium-, silicone- and lead-free, matt, low-adhesion, machine easy to process, abrasion-resistant, hydrolysis and microbial resistant
Shore hardness (jacket)	90 ±5 A
Outer-Ø (jacket)	4.1 mm ±5%
Color (jacket)	gray
chemical resistance	good resistance to oil, gasoline and chemicals (EN 60811-404)
thermal resistance	flame retardand UL 1581 Section 1090 (H), CSA FT2 / IEC 60332-2-2
Nominal voltage	300 V AC
Test voltage	2500 V AC
Current load capacity	to DIN VDE 0298-4
Temperature range (fixed)	-40...+80 °C, (+90 °C at max. 10 000 operating hours)
Temperature range (mobile)	-25...+80 °C, (+90 °C at max. 10 000 operating hours)
Bend radius (fixed)	5× outer Ø
Bend radius (moving)	10× outer Ø
No. of bending cycles (C-track)	max. 10 Mio. (25 °C)
Travel speed (C-track)	max. 3 m/s
Acceleration (C-track)	max. 10 m/s ²
Torsion stress	±180°/m

No. of torsion cycles	max. 2 Mio. (25 °C)
Torsion speed	35 cycles/min
Jacket Color	gray

Commercial data

country of origin	DE
customs tariff number	85444290
EAN	4048879186070
eClass	27279218
Packaging unit	1

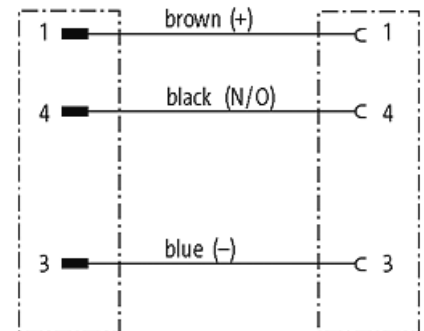
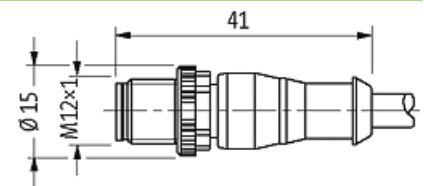
Sketch

Male

Female

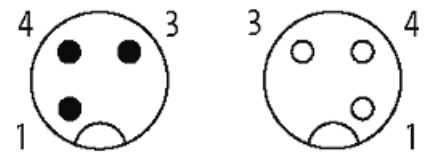

Product may differ from Image