

Reversing contactor assembly AC-3, 4 kW/400 V, 24 V DC 3-pole,
Size S00 screw terminal electrical and mechanical interlock



product brand name	SIRIUS
Product designation	Reversing contactor assembly
Product type designation	3RA23
Manufacturer's article number	<ul style="list-style-type: none"> • 1 of the supplied contactor 3RT2016-1BB42 • 2 of the supplied contactor 3RT2016-1BB42 • of the supplied RH assembly kit 3RA2913-2AA1

General technical data	
Size of contactor	S00
Product extension	<ul style="list-style-type: none"> • Auxiliary switch Yes • Insulation voltage with degree of pollution 3 at AC rated value 690 V
Surge voltage resistance rated value	6 kV
<ul style="list-style-type: none"> • protection class IP on the front 	IP20
Shock resistance at rectangular impulse	<ul style="list-style-type: none"> • at AC 6,7g / 5 ms, 4,2g / 10 ms • at DC 6,7g / 5 ms, 4,2g / 10 ms
Shock resistance with sine pulse	

<ul style="list-style-type: none"> • at AC 	10,5g / 5 ms, 6,6g / 10 ms
<ul style="list-style-type: none"> • at DC 	10,5g / 5 ms, 6,6g / 10 ms
Mechanical service life (switching cycles)	
<ul style="list-style-type: none"> • of contactor typical 	10 000 000
<ul style="list-style-type: none"> • of the contactor with added auxiliary switch block typical 	10 000 000
Reference code acc. to DIN EN 81346-2	Q

Ambient conditions

Installation altitude at height above sea level	
<ul style="list-style-type: none"> • maximum 	2 000 m
Ambient temperature	
<ul style="list-style-type: none"> • during operation 	-25 ... +60 °C
<ul style="list-style-type: none"> • during storage 	-55 ... +80 °C

Main circuit

Number of poles for main current circuit	3
Number of NO contacts for main contacts	3
Number of NC contacts for main contacts	0
Operating voltage	
<ul style="list-style-type: none"> • at AC-3 rated value maximum 	690 V
Operating current	
<ul style="list-style-type: none"> • at AC-3 <ul style="list-style-type: none"> — at 400 V rated value 	9 A
Operating current	
<ul style="list-style-type: none"> • at 1 current path at DC-1 <ul style="list-style-type: none"> — at 24 V rated value — at 110 V rated value • with 2 current paths in series at DC-1 <ul style="list-style-type: none"> — at 24 V rated value — at 110 V rated value • with 3 current paths in series at DC-1 <ul style="list-style-type: none"> — at 24 V rated value — at 110 V rated value 	20 A 2.1 A 20 A 12 A 20 A 20 A
Operating current	
<ul style="list-style-type: none"> • at 1 current path at DC-3 at DC-5 <ul style="list-style-type: none"> — at 24 V rated value — at 110 V rated value • with 2 current paths in series at DC-3 at DC-5 <ul style="list-style-type: none"> — at 24 V rated value — at 110 V rated value • with 3 current paths in series at DC-3 at DC-5 <ul style="list-style-type: none"> — at 24 V rated value 	20 A 0.15 A 20 A 0.35 A 20 A

— at 110 V rated value	20 A
Operating power	
• at AC-3	
— at 400 V rated value	4 kW
— at 500 V rated value	4.5 kW
— at 690 V rated value	5.5 kW
• at AC-4 at 400 V rated value	4 kW
No-load switching frequency	1 500 1/h
Operating frequency at AC-3 maximum	750 1/h

Control circuit/ Control	
Type of voltage of the control supply voltage	DC
Control supply voltage 1	
• at DC rated value	24 V
Closing power of magnet coil at DC	4 W
Holding power of magnet coil at DC	4 W

Auxiliary circuit	
Operating current of auxiliary contacts at AC-12 maximum	10 A
• Operating current of auxiliary contacts at AC-15 at 230 V	6 A
• operating current of auxiliary contacts at AC-15 at 400 V	3 A
• operating current of auxiliary contacts at DC-13 at 24 V	10 A
• Operating current of auxiliary contacts at DC-13 at 60 V	2 A
• Operating current of auxiliary contacts at DC-13 at 110 V	1 A
• Operating current of auxiliary contacts at DC-13 at 220 V	0.3 A
contact reliability of auxiliary contacts	< 1 error per 100 million operating cycles

UL/CSA ratings	
Full-load current (FLA) for three-phase AC motor	
• at 480 V rated value	7.6 A
• at 600 V rated value	9 A
Yielded mechanical performance [hp]	
• for single-phase AC motor	
— at 110/120 V rated value	0.33 hp
— at 230 V rated value	1 hp
• for three-phase AC motor	
— at 200/208 V rated value	2 hp
— at 220/230 V rated value	3 hp

— at 460/480 V rated value	5 hp
— at 575/600 V rated value	7.5 hp
Contact rating of auxiliary contacts according to UL	A600 / Q600

Short-circuit protection

Design of the fuse link	
<ul style="list-style-type: none"> • for short-circuit protection of the main circuit <ul style="list-style-type: none"> — with type of coordination 1 required — with type of assignment 2 required • for short-circuit protection of the auxiliary switch required 	gG NH 3NA, DIAZED 5SB, NEOZED 5SE: 35 A gG NH 3NA, DIAZED 5SB, NEOZED 5SE: 20 A fuse gG: 10 A





Installation/ mounting/ dimensions

• mounting position	+/-180° rotation possible on vertical mounting surface; can be tilted forward and backward by +/- 22.5° on vertical mounting surface
Mounting type	screw and snap-on mounting onto 35 mm standard mounting rail
Height	68 mm
Width	90 mm
Depth	73 mm
Required spacing	
<ul style="list-style-type: none"> • with side-by-side mounting <ul style="list-style-type: none"> — forwards — Backwards — upwards — downwards — at the side • for grounded parts <ul style="list-style-type: none"> — forwards — Backwards — upwards — at the side — downwards • for live parts <ul style="list-style-type: none"> — forwards — Backwards — upwards — downwards — at the side 	6 mm 0 mm 6 mm 6 mm 6 mm 6 mm 6 mm 0 mm 6 mm 6 mm 6 mm 6 mm 6 mm 0 mm 6 mm 6 mm 6 mm



Connections/ Terminals

• Type of electrical connection for main current circuit	screw-type terminals
--	----------------------

<ul style="list-style-type: none"> • Type of electrical connection for auxiliary and control current circuit 	screw-type terminals
Type of connectable conductor cross-sections <ul style="list-style-type: none"> • for main contacts <ul style="list-style-type: none"> — solid — single or multi-stranded — finely stranded with core end processing • at AWG conductors for main contacts 	2x (0.5 ... 1.5 mm ²), 2x (0.75 ... 2.5 mm ²), 2x 4 mm ² 2x (0,5 ... 1,5 mm ²), 2x (0,75 ... 2,5 mm ²), 2x (0,5 ... 4 mm ²) 2x (0.5 ... 1.5 mm ²), 2x (0.75 ... 2.5 mm ²) 2x (20 ... 16), 2x (18 ... 14)
Type of connectable conductor cross-sections <ul style="list-style-type: none"> • for auxiliary contacts <ul style="list-style-type: none"> — single or multi-stranded — finely stranded with core end processing • at AWG conductors for auxiliary contacts 	2x (0,5 ... 1,5 mm ²), 2x (0,75 ... 2,5 mm ²) 2x (0.5 ... 1.5 mm ²), 2x (0.75 ... 2.5 mm ²) 2x (20 ... 16), 2x (18 ... 14)
Safety related data	
B10 value <ul style="list-style-type: none"> • with high demand rate acc. to SN 31920 	1 000 000
Proportion of dangerous failures <ul style="list-style-type: none"> • with low demand rate acc. to SN 31920 • with high demand rate acc. to SN 31920 	40 % 75 %
Failure rate [FIT] <ul style="list-style-type: none"> • with low demand rate acc. to SN 31920 	100 FIT
T1 value for proof test interval or service life acc. to IEC 61508	20 y
Communication/ Protocol	
product function bus communication	Yes
Protocol is supported <ul style="list-style-type: none"> • AS-Interface protocol 	No
Product function Control circuit interface with IO link	No
Certificates/ approvals	

General Product Approval			Declaration of Conformity	Test Certificates
				Miscellaneous Type Test Certificates/Test Report

Test Certificates	Marine / Shipping				
Special Test Certificate					
	ABS	BUREAU VERITAS	LRS	PRS	RINA

Marine / Shipping	other	Railway
	Confirmation	Vibration and Shock
		
RMRS		

Further information

Information- and Downloadcenter (Catalogs, Brochures,...)

<https://www.siemens.com/ic10>

Industry Mall (Online ordering system)

<https://mall.industry.siemens.com/mall/en/en/Catalog/product?mlfb=3RA2316-8XB30-1BB4>

Cax online generator

<http://support.automation.siemens.com/WW/CAXorder/default.aspx?lang=en&mlfb=3RA2316-8XB30-1BB4>

Service&Support (Manuals, Certificates, Characteristics, FAQs,...)

<https://support.industry.siemens.com/cs/ww/en/ps/3RA2316-8XB30-1BB4>

Image database (product images, 2D dimension drawings, 3D models, device circuit diagrams, EPLAN macros, ...)

http://www.automation.siemens.com/bilddb/cax_de.aspx?mlfb=3RA2316-8XB30-1BB4&lang=en

Characteristic: Tripping characteristics, I²t, Let-through current

<https://support.industry.siemens.com/cs/ww/en/ps/3RA2316-8XB30-1BB4/char>

Further characteristics (e.g. electrical endurance, switching frequency)

<http://www.automation.siemens.com/bilddb/index.aspx?view=Search&mlfb=3RA2316-8XB30-1BB4&objecttype=14&gridview=view1>

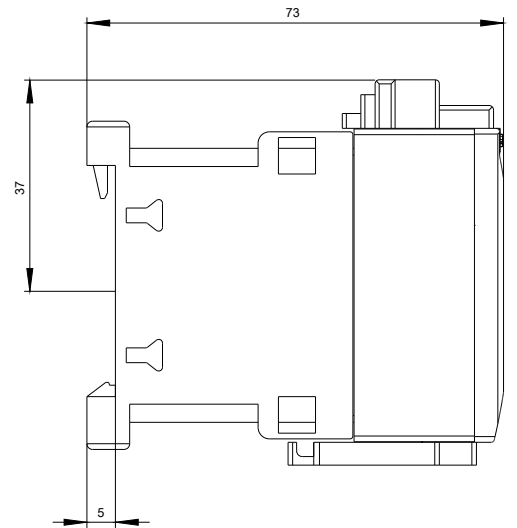
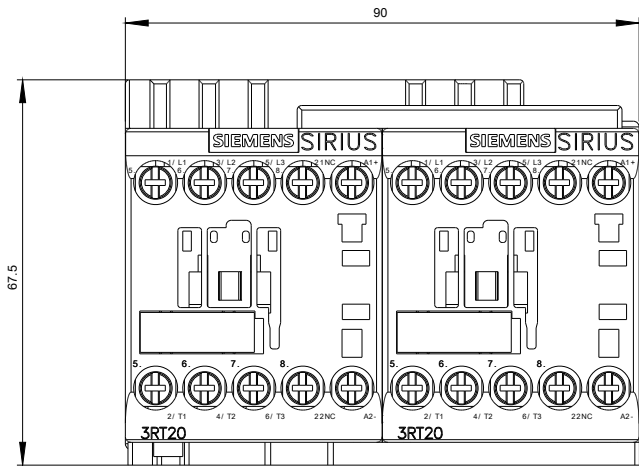

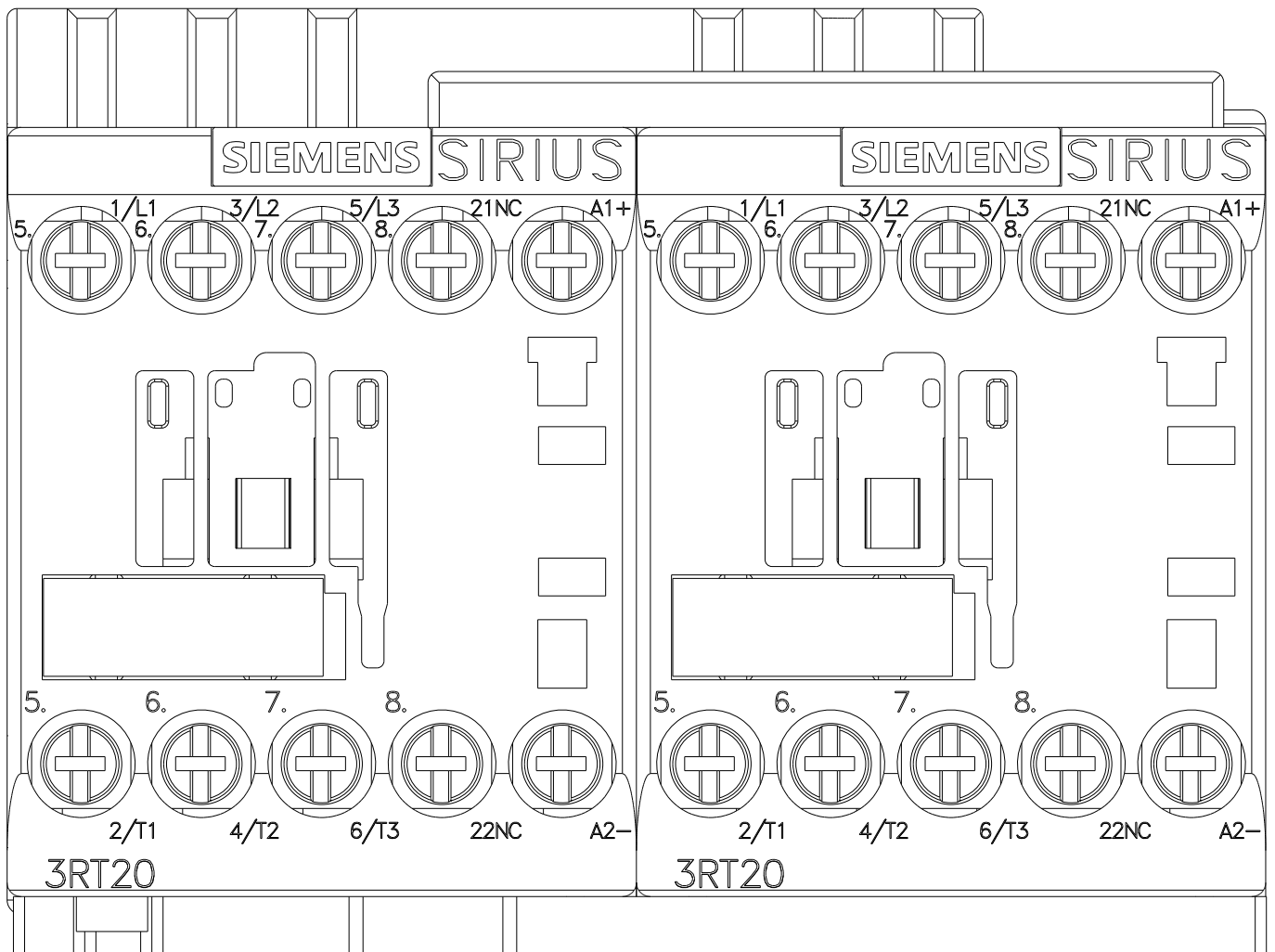

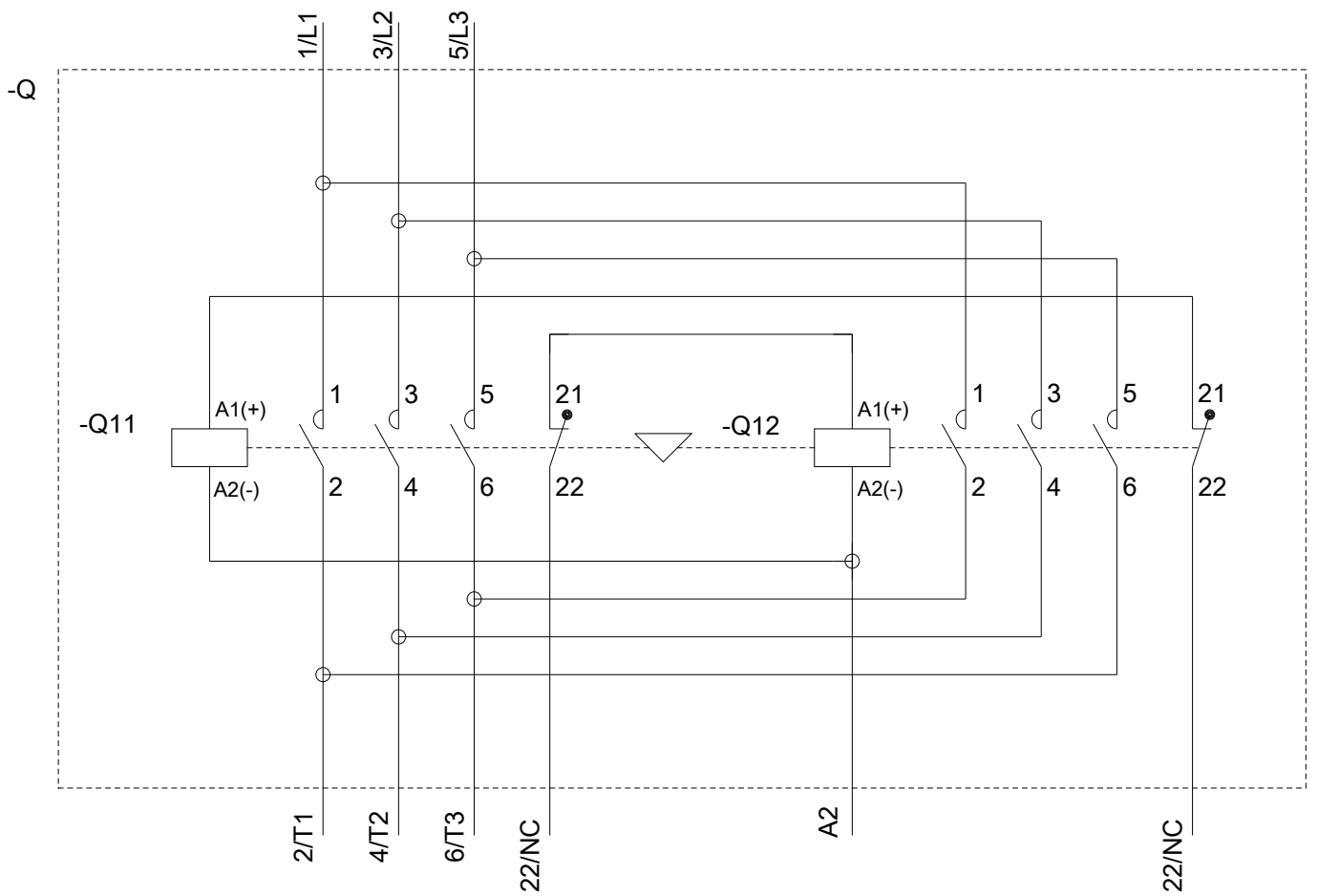

last modified:

08/13/2020