

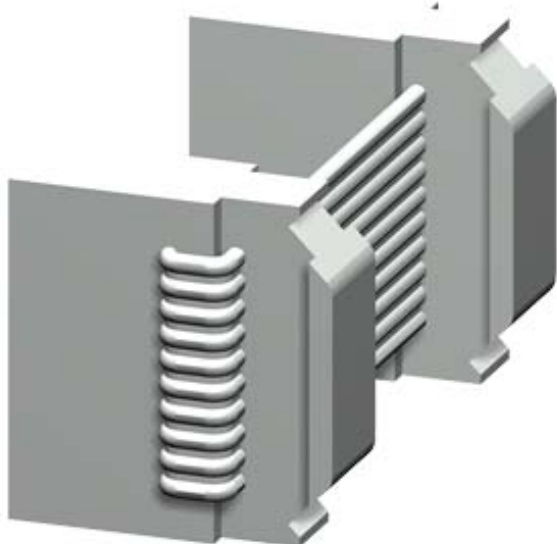





cable de enlace Longitud 0,5 m, plano, para conectar la unidad base, Módulo de medida de intensidad, módulo de medida de intensidad/tensión, bloque de control de operador o módulos de ampliación a través de la interfaz del sistema







Datos técnicos generales

Nombre comercial del producto	SIRIUS
Designación del producto	Cable de conexión
Tipo de producto	Longitud 0,5 m, plano
Temperatura ambiente	
• durante el almacenamiento	-40 ... +80 °C
• durante el funcionamiento	-25 ... +60 °C
• durante el transporte	-40 ... +80 °C

Certificados/ Homologaciones

General Product Approval			EMC	Declaration of Conformity	Test Certificates
 CSA	 UL		 RCM	 EG-Konf.	Type Test Certificates/Test Report

Shipping Approval				other
 ABS	 LRS	 PRS	 RMRS	Confirmation  Profibus

other
PROFINET-Certification

Más información

Information- and Downloadcenter (Catálogos, Folletos,...)

<https://www.siemens.com/ic10>

Industry Mall (sistema de pedido online)

<https://mall.industry.siemens.com/mall/es/es/Catalog/product?mlfb=3UF7932-0AA00-0>

Generador CAX online

<http://support.automation.siemens.com/WW/CAXorder/default.aspx?lang=en&mlfb=3UF7932-0AA00-0>

Service&Support (Manuales, certificados, características, FAQ,...)

<https://support.industry.siemens.com/cs/ww/es/ps/3UF7932-0AA00-0>

Base de datos de imágenes (fotos de producto, dibujos acotados 2D, modelos 3D, esquemas de conexiones, macros

EPLAN, ...)

http://www.automation.siemens.com/bilddb/cax_de.aspx?mlfb=3UF7932-0AA00-0&lang=en

