

inserto piatto per pulsante luminoso, rotondo, opalescente con scritta nera. con simbolo grafico movimento rotatorio a destra



marca del prodotto	SIRIUS ACT
denominazione del prodotto	Inserto piatto
designazione del tipo di prodotto	3SU1





Dati tecnici generali



Resistenza agli urti <ul style="list-style-type: none"> per applicazioni ferroviarie secondo EN 61373 	categoria 1, classe B
Resistenza a vibrazioni <ul style="list-style-type: none"> per applicazioni ferroviarie secondo EN 61373 	categoria 1, classe B

Accessori

Materiale degli accessori	plastica
Tipo di fissaggio della targhetta	inserire
Marchatura dell'inserto piatto	SIMBOLO: MOVIMENTO ROTATORIO VERSO DESTRA
Forma dell'inserto piatto	rotondo
Colore dell'inserto piatto	opalescente/nero (targhetta/iscrizione)
Simboli ISO stampati	SIMBOLO: MOVIMENTO ROTATORIO A DESTRA

Certificati/ Approvazioni

General Product Approval		Declaration of Conformity		Test Certificates
 CSA	 UL		 EG-Konf.	Miscellaneous Type Test Certificates/Test Report

Marine / Shipping					other
 ABS	 LRS	 PRS	 RINA	 RMRS	Confirmation

Ulteriori informazioni

Information- and Downloadcenter (Cataloghi, Opuscoli,...)

<https://www.siemens.com/ic10>

Industry Mall (sistema di ordinazione Online)

<https://mall.industry.siemens.com/mall/it/it/Catalog/product?mlfb=3SU1900-0AB71-0QT0>

Generatore CAx online

<http://support.automation.siemens.com/WW/CAXorder/default.aspx?lang=en&mlfb=3SU1900-0AB71-0QT0>

Service&Support (Manuali, Certificati, Caratteristiche, FAQ, ...)

<https://support.industry.siemens.com/cs/ww/it/ps/3SU1900-0AB71-0QT0>

Banca dati immagini (foto prodotto, disegni dimensionali 2D, modelli 3D, schemi delle connessioni, macro EPLAN...)

http://www.automation.siemens.com/bilddb/cax_de.aspx?mlfb=3SU1900-0AB71-0QT0&lang=en

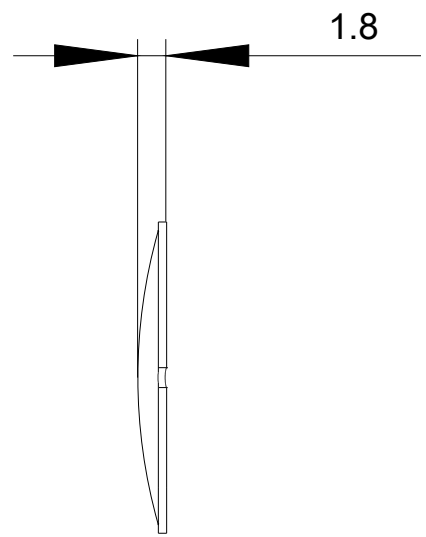
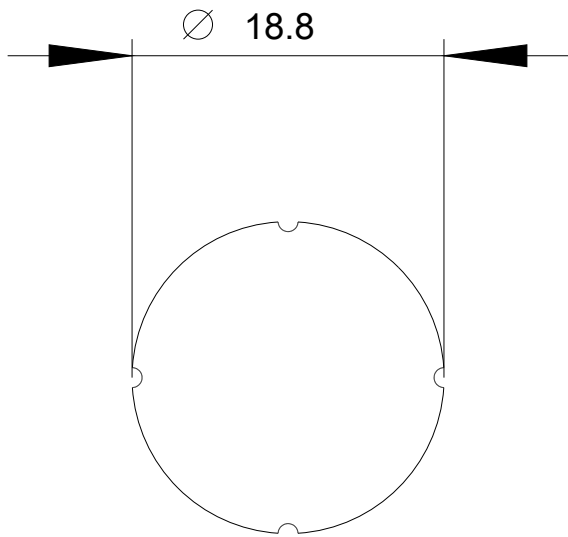

Ultima modifica:

06/08/2020