

EMSKE 32 EMV-Z

Ex-EMC cable gland, earthing cones DIN 89345, brass nickel-plated, M32

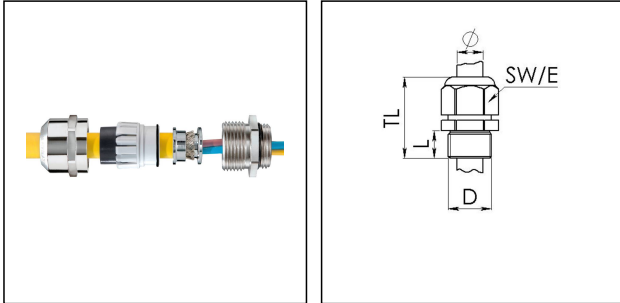

Products may differ in size, colour and appearance to those shown. If you require further information or customisation, please contact us directly.



Material cable gland	Brass nickel-plated
Material clamping cage	Polyamide
Material sealing gasket	EPDM
Temp. range min	-40 °C
Temp. range max	75 °C
Protection class	IP66 / IP68 (5 bar 30 min)
Type of protection	Ex eb, Ex tb
Ex-Certificate	ATEX, IECEx
Thread type	M
Ø Connection thread D	32
Lead	1,5
Length screw-in thread L	8 mm
Ø cable diameter min	13 mm
Ø cable diameter max	21 mm
Ø cable below cable shield	20 mm
Ø cable diameter UL	14,6 mm - 19,5 mm
Key width SW	36 mm
Collar diameter (E)	40 mm
Total length TL	36 mm - 44 mm
Install. torques fitting	20 N m
Install. torques cap nut	20 N m
Surface	Nickel-plated
Order no. nickel-plated	10065060
Type	EMSKE 32 EMV-Z
Packing unit	25

Your Contact:

WISKA Hoppmann GmbH

Kisdorfer Weg 28 · 24568 Kaltenkirchen · Germany

☎ +49-4191-508-0 · 📠 +49-4191-508-209

contact@wiska.de · www.wiska.com

ETIM-Classification

EC000441

Recommended accessories

RDE 32	10062186
EMMU-EMV 32	10063214
BS 21	10064014

14.01.2021

Your Contact:

WISKA Hoppmann GmbH

Kisdorfer Weg 28 · 24568 Kaltenkirchen · Germany

☎ +49-4191-508-0 · 📠 +49-4191-508-209

contact@wiska.de · www.wiska.com



Your Contact:

WISKA Hoppmann GmbH

Kisdorfer Weg 28 · 24568 Kaltenkirchen · Germany

☎ +49-4191-508-0 · 📠 +49-4191-508-209

contact@wiska.de · www.wiska.com